

BlueEva+S Evaluation Kit User Guide

1VV0301283 Rev. 05 – 2016-09-29



APPLICABILITY TABLE

PRODUCT
BlueEva+S
BlueEva+S/Central



SPECIFICATIONS SUBJECT TO CHANGE WITHOUT NOTICE

Notice

While reasonable efforts have been made to assure the accuracy of this document, Telit assumes no liability resulting from any inaccuracies or omissions in this document, or from use of the information obtained herein. The information in this document has been carefully checked and is believed to be entirely reliable. However, no responsibility is assumed for inaccuracies or omissions. Telit reserves the right to make changes to any products described herein and reserves the right to revise this document and to make changes from time to time in content hereof with no obligation to notify any person of revisions or changes. Telit does not assume any liability arising out of the application or use of any product, software, or circuit described herein; neither does it convey license under its patent rights or the rights of others.

It is possible that this publication may contain references to, or information about Telit products (machines and programs), programming, or services that are not announced in your country. Such references or information must not be construed to mean that Telit intends to announce such Telit products, programming, or services in your country.

Copyrights

This instruction manual and the Telit products described in this instruction manual may be, include or describe copyrighted Telit material, such as computer programs stored in semiconductor memories or other media. Laws in the Italy and other countries preserve for Telit and its licensors certain exclusive rights for copyrighted material, including the exclusive right to copy, reproduce in any form, distribute and make derivative works of the copyrighted material. Accordingly, any copyrighted material of Telit and its licensors contained herein or in the Telit products described in this instruction manual may not be copied, reproduced, distributed, merged or modified in any manner without the express written permission of Telit. Furthermore, the purchase of Telit products shall not be deemed to grant either directly or by implication, estoppel, or otherwise, any license under the copyrights, patents or patent applications of Telit, as arises by operation of law in the sale of a product.

Computer Software Copyrights

The Telit and 3rd Party supplied Software (SW) products described in this instruction manual may include copyrighted Telit and other 3rd Party supplied computer programs stored in semiconductor memories or other media. Laws in the Italy and other countries preserve for Telit and other 3rd Party supplied SW certain exclusive rights for copyrighted computer programs, including the exclusive right to copy or reproduce in any form the copyrighted computer program. Accordingly, any copyrighted Telit or other 3rd Party supplied SW computer programs contained in the Telit products described in this instruction manual may not be copied (reverse engineered) or reproduced in any manner without the express written permission of Telit or the 3rd Party SW supplier. Furthermore, the purchase of Telit products shall not be deemed to grant either directly or by implication, estoppel, or otherwise, any license under the copyrights, patents or patent applications of Telit or other 3rd Party supplied SW, except for the normal non-exclusive, royalty free license to use that arises by operation of law in the sale of a product.



Usage and Disclosure Restrictions

License Agreements

The software described in this document is the property of Telit and its licensors. It is furnished by express license agreement only and may be used only in accordance with the terms of such an agreement.

Copyrighted Materials

Software and documentation are copyrighted materials. Making unauthorized copies is prohibited by law. No part of the software or documentation may be reproduced, transmitted, transcribed, stored in a retrieval system, or translated into any language or computer language, in any form or by any means, without prior written permission of Telit

High Risk Materials

Components, units, or third-party products used in the product described herein are NOT fault-tolerant and are NOT designed, manufactured, or intended for use as on-line control equipment in the following hazardous environments requiring fail-safe controls: the operation of Nuclear Facilities, Aircraft Navigation or Aircraft Communication Systems, Air Traffic Control, Life Support, or Weapons Systems (High Risk Activities"). Telit and its supplier(s) specifically disclaim any expressed or implied warranty of fitness for such High Risk Activities.

Trademarks

TELIT and the Stylized T Logo are registered in Trademark Office. All other product or service names are the property of their respective owners.

Third Party Rights

The software may include Third Party Right software. In this case you agree to comply with all terms and conditions imposed on you in respect of such separate software. In addition to Third Party Terms, the disclaimer of warranty and limitation of liability provisions in this License shall apply to the Third Party Right software.

TELIT HEREBY DISCLAIMS ANY AND ALL WARRANTIES EXPRESS OR IMPLIED FROM ANY THIRD PARTIES REGARDING ANY SEPARATE FILES, ANY THIRD PARTY MATERIALS INCLUDED IN THE SOFTWARE, ANY THIRD PARTY MATERIALS FROM WHICH THE SOFTWARE IS DERIVED (COLLECTIVELY "OTHER CODE"), AND THE USE OF ANY OR ALL THE OTHER CODE IN CONNECTION WITH THE SOFTWARE, INCLUDING (WITHOUT LIMITATION) ANY WARRANTIES OF SATISFACTORY QUALITY OR FITNESS FOR A PARTICULAR PURPOSE.

NO THIRD PARTY LICENSORS OF OTHER CODE SHALL HAVE ANY LIABILITY FOR ANY DIRECT, INDIRECT, INCIDENTAL, SPECIAL, EXEMPLARY, OR CONSEQUENTIAL DAMAGES (INCLUDING WITHOUT LIMITATION LOST PROFITS), HOWEVER CAUSED AND WHETHER MADE UNDER CONTRACT, TORT OR OTHER LEGAL THEORY, ARISING IN ANY WAY OUT OF THE USE OR DISTRIBUTION OF THE OTHER CODE OR THE EXERCISE OF ANY RIGHTS GRANTED UNDER EITHER OR BOTH THIS LICENSE AND THE LEGAL TERMS APPLICABLE TO ANY SEPARATE FILES, EVEN IF ADVISED OF THE POSSIBILITY OF SUCH DAMAGES.

Copyright © Telit Communications S.p.A. 2016.



Contents

1. Introduction	7
1.1. Scope.....	7
1.2. Audience	7
1.3. Contact Information, Support	7
1.4. Text Conventions	8
1.5. Related Documents.....	8
2. Package Content	9
3. Hardware	10
3.1. BlueMod+S	10
3.2. Reset.....	10
3.3. USB Interface.....	10
3.4. LEDs	11
3.5. External Low Power Oscillator	11
3.6. Connectors / Jumpers	11
3.6.1. Jumper J2.....	11
3.6.2. Jumper J3.....	11
3.6.3. Jumper J4.....	12
3.6.4. Connector X2.....	12
3.6.5. Connector X3.....	13
3.6.6. Connector X4.....	14
3.7. Current Measurement	14
3.8. Power Supply	14
3.8.1. USB Power Supply	14
3.8.2. External Power Supply.....	14
3.8.3. Battery Holder.....	14
3.9. Buzzer.....	14
3.10. Push Button	14
3.11. How To Interface the UART Lines on TTL level.....	15
3.12. Default Configuration	16
4. Setup	17
4.1. System Requirements.....	17



- 4.2. Startup..... 17
- 4.3. Installation of the BlueEva+S USB Driver 17
- 5. Usage of the BlueEva+S 18**
 - 5.1. Configuration of the BlueEva+S 18
 - 5.2. Connection with Telit “Terminal IO Utility” App..... 19
- 6. Firmware Update 25**
 - 6.1. Serial Firmware Upgrade (UART) 25
 - 6.2. Firmware Update Over The Air (OTA)..... 27
 - 6.3. Firmware Update Over The Air using Nordic nRF Toolbox on Android 27
- 7. Document History..... 31**



1. Introduction

1.1. Scope

This document describes the usage of the evaluation kit for the Bluetooth module BlueMod+S.

1.2. Audience

This document is intended for Telit customers, especially system integrators, about to implement Bluetooth modules in their application.

1.3. Contact Information, Support

For general contact, technical support, to report documentation errors and to order manuals, contact Telit Technical Support Center (TTSC) at:

TS-SRD@telit.com

Alternatively, use:

<http://www.telit.com/support>

For detailed information about where you can buy the Telit modules or for recommendations on accessories and components visit:

<http://www.telit.com>

To register for product news and announcements or for product questions contact Telit Technical Support Center (TTSC).

Our aim is to make this guide as helpful as possible. Keep us informed of your comments and suggestions for improvements.

Telit appreciates feedback from the users of our information.



1.4. Text Conventions



Danger – This information MUST be followed or catastrophic equipment failure or bodily injury may occur.



Caution or Warning – Alerts the user to important points about integrating the module, if these points are not followed, the module and end user equipment may fail or malfunction.



Tip or Information – Provides advice and suggestions that may be useful when integrating the module.

All dates are in ISO 8601 format, i.e. YYYY-MM-DD.

1.5. Related Documents

- [1] BlueMod+S Hardware Reference, 1VV0301275
- [2] BlueMod+S AT Command Reference, 80507ST10754A
- [3] BlueMod+S Test Mode Reference
- [4] BlueEva+S Schematic



2. Package Content

The BlueEva+S package contains the following components:

- 1 x BlueEva+S board
- 1 x Mini USB cable
- 1 x Battery CR2032
- 1 x Printed card with download instructions



3. Hardware

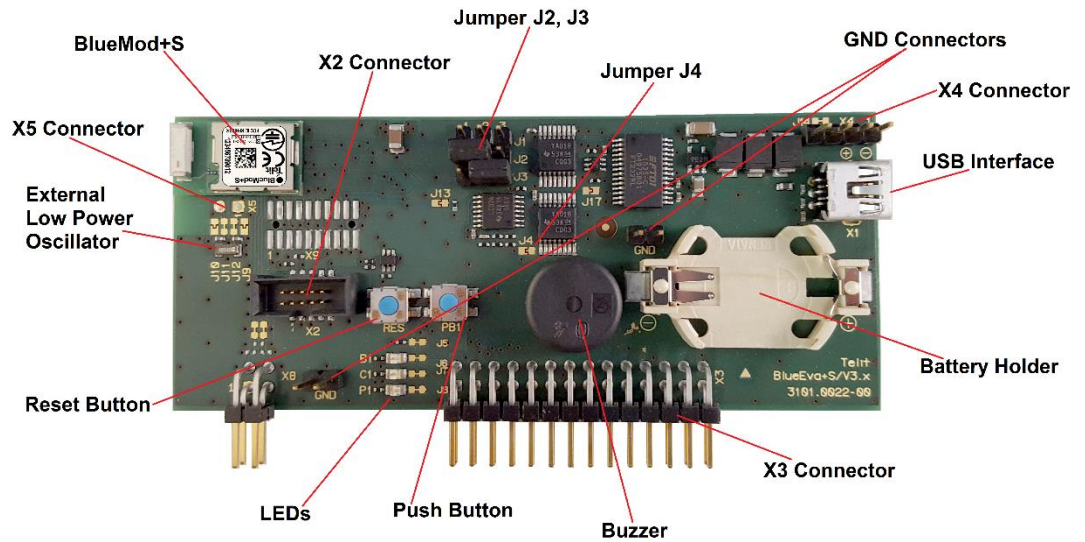

Figure 1 BlueEva+S

3.1. BlueMod+S

The BlueEva+S is equipped with a BlueMod+S Bluetooth module.

3.2. Reset

The BlueEva+S is equipped with a reset button. Pressing the reset button will trigger the BlueMod+S module to perform a reset. The USB port is not influenced by the reset.

3.3. USB Interface

The BlueEva+S provides an USB interface which is used to connect the evaluation board to the host and as power supply.

The USB interface is equipped with an FTDI USB to serial bridge, interfacing the serial port of the BlueMod+S.

The serial port is a high-speed UART interface at CMOS levels and supports the following features:

- Transmission speed: 9,600 – 921,600 bps (asynchronous)
- Character representation: 8 bit, no parity, 1 stop bit (8N1)
- Hardware flow-control with RTS/CTS (active low)

For details please refer to the *BlueMod+S Hardware Reference*.



3.4. LEDs

The BlueEva+S provides several LEDs for functional indication.

Interface	Position	Function
LEDs	B1	Connected to GPIO[3] ⁽¹⁾
	C1	Connected to GPIO[2] ⁽¹⁾
	P1	Indicates the presence of power supply voltage

(1) Function depending on firmware support.

3.5. External Low Power Oscillator

The BlueEva+S provides an external low power crystal. This is connected to the BlueMod+S by default. For using alternatively low power oscillator sources refer to the schematics and the *BlueMod+S Hardware Reference*.

3.6. Connectors / Jumpers

3.6.1. Jumper J2

Jumper J2 provides the possibility to invoke the bootloader at start-up. This is required for firmware update.

Jumper Number	Position	Function
J2	1-2	Normal application start
J2	2-3	Invoke bootloader at start-up (BOOT0)

3.6.2. Jumper J3

Jumper J3 is used for either hangup or UICP functionality.

In hangup mode DTR# is connected to GPIO[4]. An existing connection is terminated by DTR drop (high signal on DTR#).

In UICP mode DTR# is used as IUR-IN# signal. UICP is an advanced power management protocol. For further information about UICP please refer to the *UICP UART Interface Control Protocol Specification*.

Jumper Number	Position	Function
J3	1-2	DTR# connected to IUR-IN#
J3	2-3	DTR# connected to GPIO[4]



3.6.3. Jumper J4

Jumper J4 provides the possibility to disable (by closing it with a soldering point) the USB to serial bridge. With a closed jumper J4, the in- and outputs of the FTDI chip are disconnected. Therefore the modules serial port can be controlled via Connector X3.

When using BlueEva+S, be sure to connect a serial interface via connector X3 only when jumper J4 is closed. Otherwise the serial interface and the USB to serial bridge will collide.

3.6.4. Connector X2

Connector X2 is used as “Debug in” to connect a debugger to the BlueMod+S module.



3.6.5. Connector X3

Connector X3 is a 28 pin extension header exposing all module signals.

Pin Number	Signal	Type	Description
1	+3V0	PWR	Supply voltage output
2	+3V0	PWR	Supply voltage output
3	GND	PWR	Ground
4	GND	PWR	Ground
5	GPIO[0]	I/O	GPIO ⁽¹⁾
6	GPIO[1]	I/O	GPIO ⁽¹⁾
7	GPIO[2]	I/O	LED C1, user IO
8	GPIO[3]	I/O	LED B1, user IO
9	GPIO[4]	I/O	GPIO ⁽¹⁾
10	GPIO[5]	I/O	GPIO ⁽¹⁾
11	GPIO[6]	I/O	GPIO ⁽¹⁾
12	GPIO[7]	I/O	GPIO ⁽¹⁾
13	GPIO[8]	I/O	GPIO ⁽¹⁾
14	GPIO[9]	I/O	GPIO ⁽¹⁾
15	GPIO[10]	I/O	GPIO ⁽¹⁾
16	GPIO[11]	I/O	GPIO ⁽¹⁾
17	GPIO[12]	I/O	GPIO ⁽¹⁾
18	GPIO[13]	I/O	GPIO ⁽¹⁾
19	GPIO[14]	I/O	GPIO ⁽¹⁾
20	PO26_AIN0		See schematic ⁽¹⁾
21	PO27_AIN1		See schematic ⁽¹⁾
22	EXT-RES#	I-PU	User reset
23	UART-TXD ⁽²⁾	O-PP	IUR data OUT
24	UART-RXD ⁽²⁾	I	IUR data IN
25	UART-CTS# ⁽²⁾	I	Flow control
26	UART-RTS# ⁽²⁾	O-PP	Flow control
27	IUR-IN# ⁽²⁾	I/O	GPIO ⁽¹⁾
28	IUR-OUT# ⁽²⁾	I/O	GPIO ⁽¹⁾

PU = PullUp, PD = PullDown, PP = PushPull, I-DIS = InputBufferDisconnected

⁽¹⁾ Function depending on firmware support

⁽²⁾ Disconnected from module, when jumper J4 is open



3.6.6. Connector X4

Connector X4 provides the possibility to measure the supply current of the BlueMod+S and to power the evaluation board with an external power supply.

Pin Number	Signal
1	GND
2	ext. PWR
3	+3V0
4	+3V0-BT

3.7. Current Measurement

Current measurement can be performed by opening (cut off) jumper J14 and measuring the current drawn by BlueMod+S between pin 3 and 4 of connector X4 (see chapter 3.6.6). The currents drawn by other peripherals on BlueEva+S are not included in this measurement.

For measuring the minimum current, the serial interface must be disconnected from the module. This can be achieved by disconnecting the USB plug and powering the board via external or battery supply or by closing solder jumper J4.

3.8. Power Supply

The three power sources are decoupled from each other by diodes connected in series. The presence of the supply voltage is indicated by LED P1.

3.8.1. USB Power Supply

V_{BUS} of the USB connector X1 directly powers the USB to serial converter and via a voltage regulator the rest of the circuitry.

3.8.2. External Power Supply

Pin 1 and 2 of connector X4 (see chapter 3.6.6) provides the possibility to connect an external power supply (see *BlueMod+S Hardware Reference*).

3.8.3. Battery Holder

The battery holder provides the possibility to run the BlueEva+S without external power (via USB or external power supply) by using a 3V coin cell battery CR2032. Opening jumper J8 will disconnect the power LED P1 and thus save 1.8mA of battery current. For safety reasons there should be permanently connected no other power supply, when a battery is inserted.

3.9. Buzzer

The Buzzer can be used to generate alarm and other audible signals.

3.10. Push Button

The Push Button can be used as input for human interaction.



3.11. How To Interface the UART Lines on TTL level



If you want to access the UART lines directly it is important to disable the onboard USB to serial bridge by closing jumper J4 with a soldering point.

All UART signals are available at connector X3 (see chapter 3.6.5) and can be connected to your application.

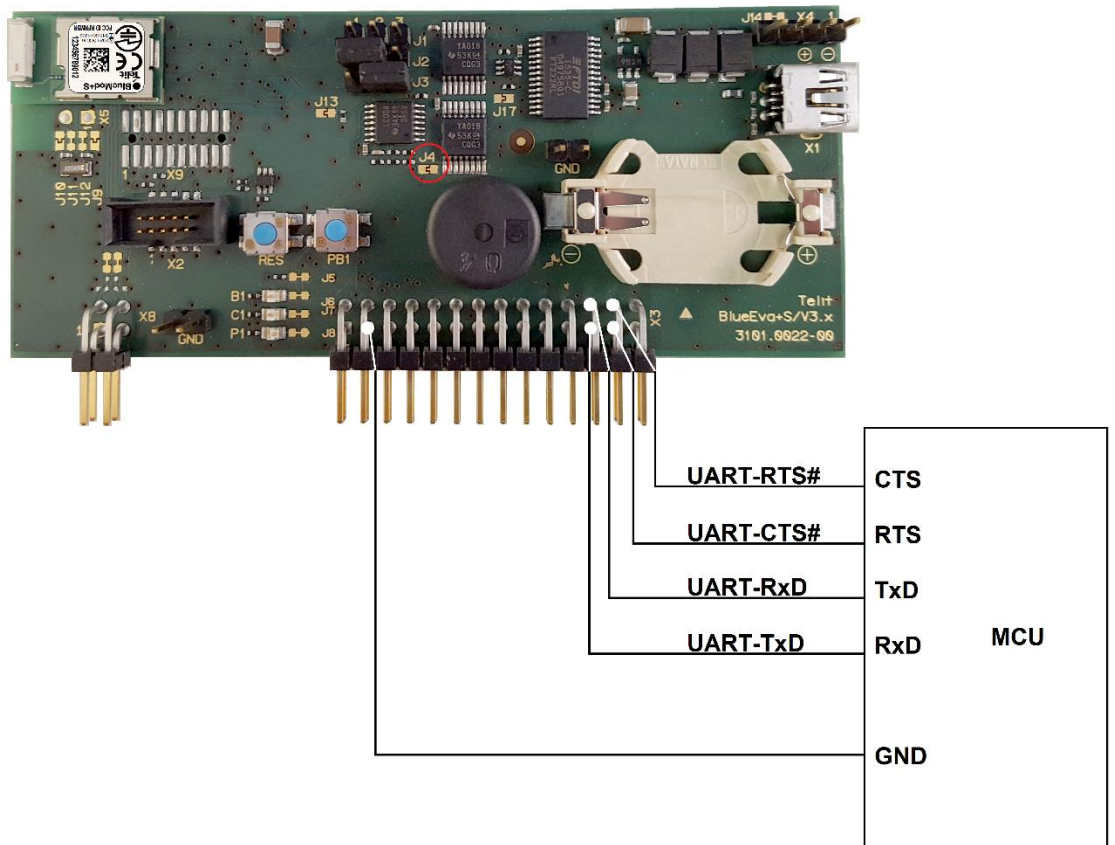

Figure 2 MCU connected to UART lines



3.12. Default Configuration

The BlueEva+S is preconfigured as described below:

Jumper Number	Position	Function
J2	1-2	Normal operation mode at start-up
J3	2-3	DTR# connected to GPIO[4] (Hangup Mode)

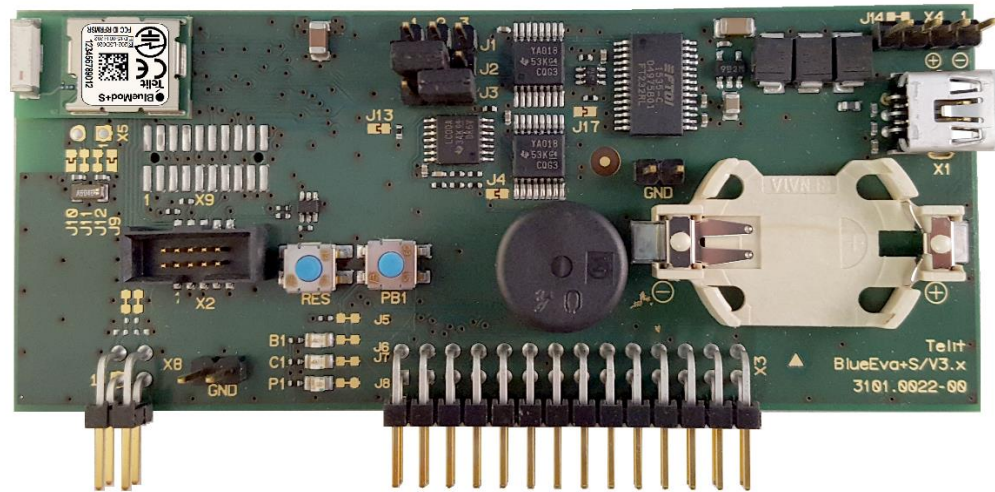

Figure 3 BlueEva+S default configuration



4. Setup

4.1. System Requirements

- PC with Windows® XP or higher
- 1 free USB port
- Adobe Acrobat® Reader for reading the documentation

4.2. Startup

To install the BlueEva+S connect it as follows.

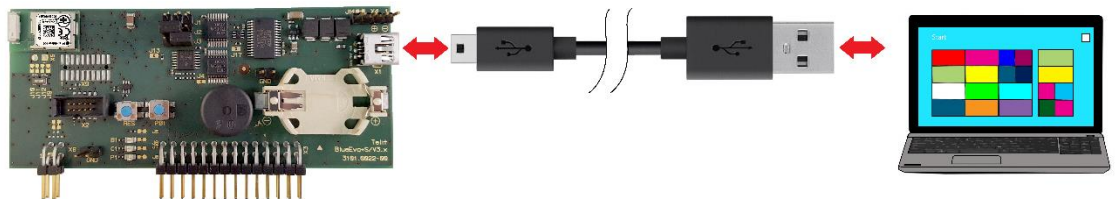

Figure 4 Connect the BlueEva+S to your PC

4.3. Installation of the BlueEva+S USB Driver

If required download the latest FTDI VCP USB to UART driver from:
<http://www.ftdichip.com/Drivers/VCP.htm>

Connect the BlueEva+S to a free USB port of a PC and install the USB device drivers by following the instructions of the Windows® Hardware Wizard using the downloaded FTDI VCP USB to UART driver.

The USB connection is used for power supply and for UART communication to a PC over a virtual COM port. This lets you use a terminal emulation program to perform the configuration or to control the Bluetooth connection.

You may download the TeraTerm terminal program from the official open source web site:
<https://en.osdn.jp/projects/ttssh2/releases/>



5. Usage of the BlueEva+S

5.1. Configuration of the BlueEva+S

If the BlueEva+S is correctly connected to the PC, a terminal emulation program can be used to read and modify the configuration settings.

For a more detailed description of the AT commands used for this purpose, please consult our *BlueMod+S AT Command Reference*.

As shipped by the factory, the BlueEva+S works at 115,200 bps, using the 8N1 data format (8 data bits, no parity, 1 stop bit). Please configure your terminal emulation program accordingly. Select the COM port the BlueEva+S is connected to (COM22 in the example below).

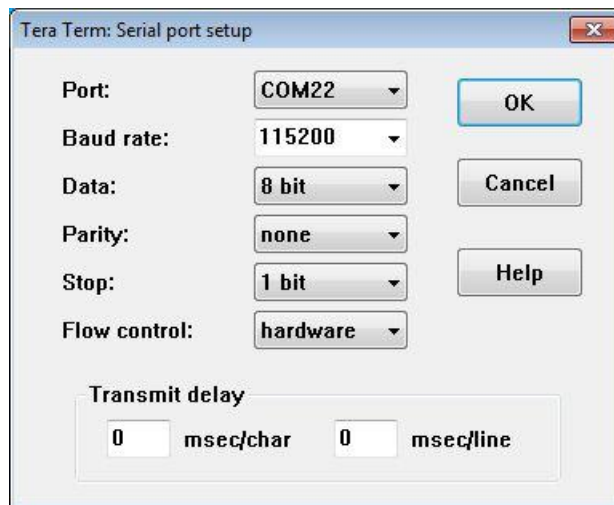

Figure 5 COM port configuration with TeraTerm

Once you have successfully configured the terminal emulation program, issuing the “AT” command without parameters should prompt the BlueEva+S to return OK.

Now you can readout information about the type of the connected device using the “ATI” command.

In the next step, you should issue the “ATI99” command to determine the firmware version installed and check to see whether that is the most recent version.

Finally, you should use the “AT+BOAD” command to determine the Bluetooth address of the BlueEva+S. The Bluetooth address is unique, letting you identify the correct device for each Bluetooth address.



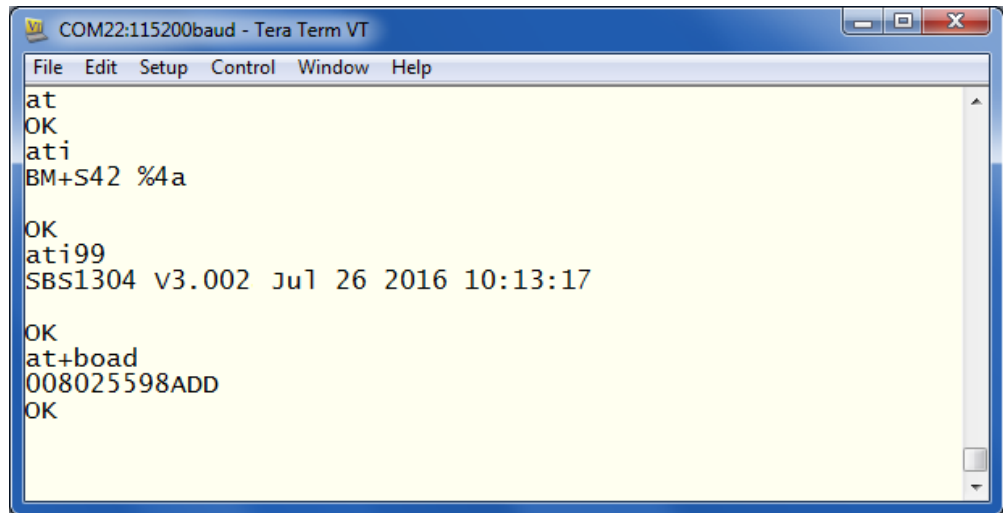

Figure 6 Reading some BlueEva+S settings with TeraTerm

5.2. Connection with Telit “Terminal IO Utility” App

Telit provides the "Terminal IO Utility" App for iPhone which can be used to establish a Bluetooth Low Energy connection from the iPhone to the BlueEva+S.

The following QR-Code provides the link to download the "Terminal IO Utility" App.



The “Terminal IO Utility” App allows the user to connect to Terminal I/O peripheral devices and exchange data providing a simple terminal emulation.



Please find an example below:

Press the “Scan” button to search for available Terminal I/O peripheral devices.

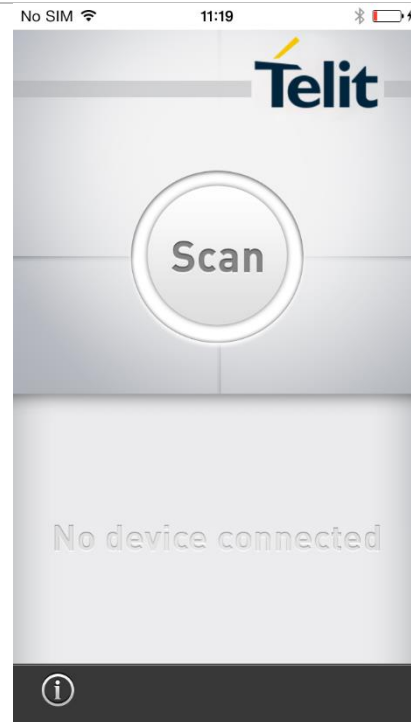

Check if your BlueEva+S device (BM+S xxxx) is found and press the “Connect” button to establish the connection to the BlueEva+S.

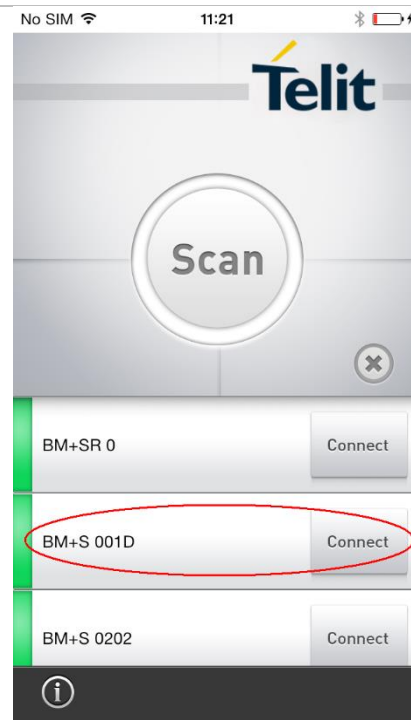

The first connection attempt will last some seconds. If the connection attempt succeeded the device status is changed to “connected”.

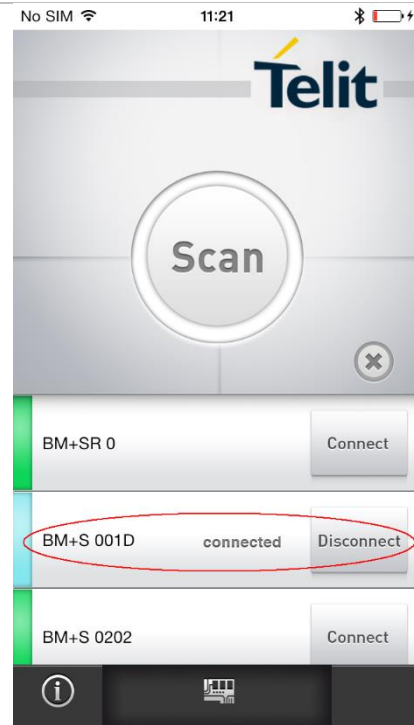

The BlueEva+S is sending a RING message followed by a CONNECT message at the serial port.

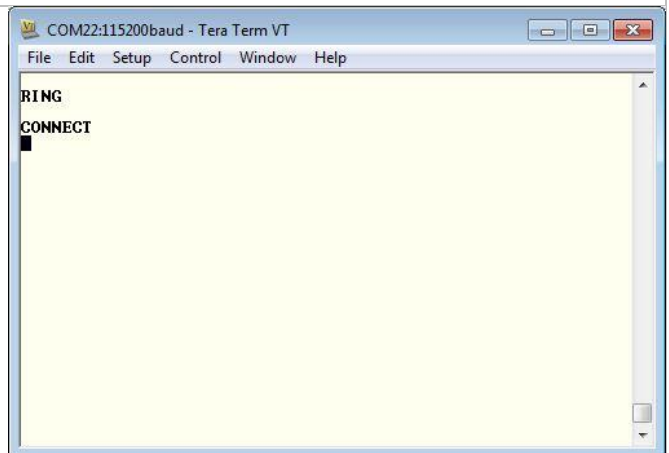

For transmitting data to the BlueEva+S click on the icon at the bottom of the page.

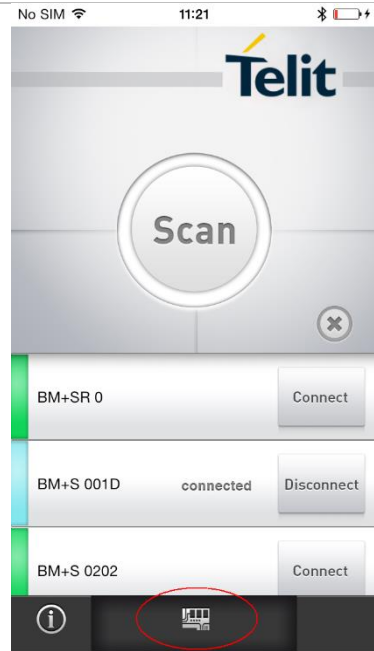

Enter data in the corresponding field and press the “Send” button.

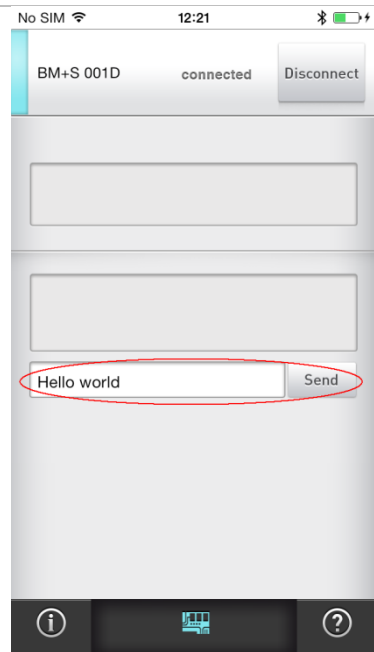

The BlueEva+S is receiving the sent data.

To send data from the BlueEva+S to the iPhone just enter the data in the terminal emulation program (data are not echoed in the example).

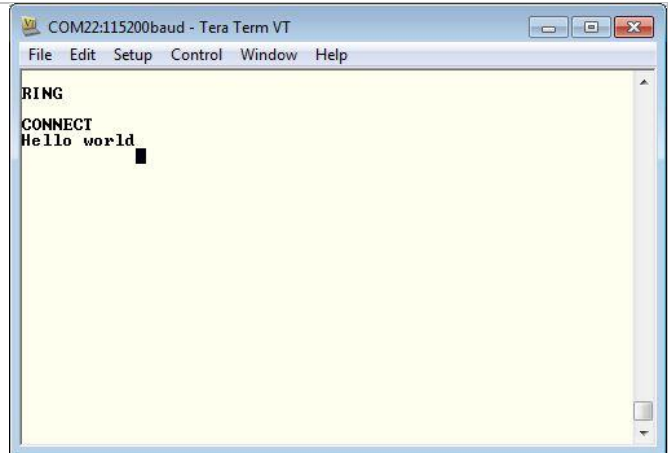

The "Terminal IO Utility" app on the iPhone is receiving the data.



To terminate the connection press the “Disconnect” button.

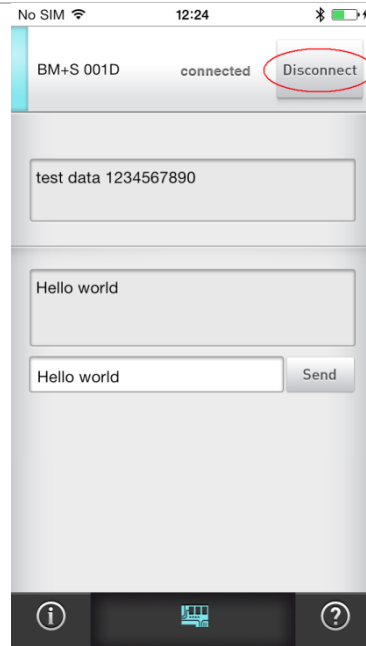

After the connection is terminated the BlueEva+S is sending a NO CARRIER message.

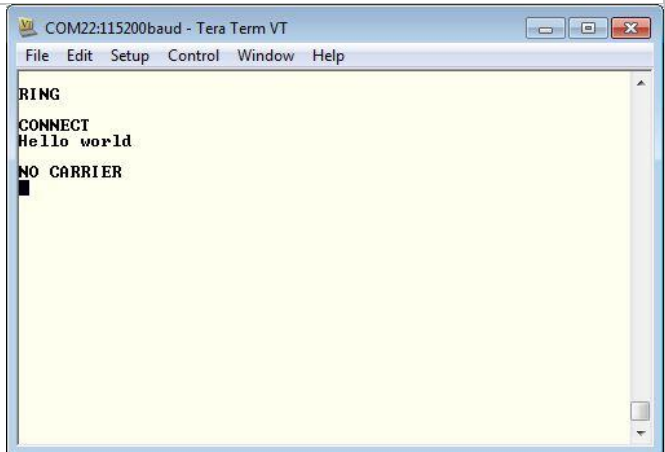

6. Firmware Update

6.1. Serial Firmware Upgrade (UART)

The firmware of the BlueEva+S can be updated by using the BlueMod+S Updater. The file name of the executable program consists of version and patch information.

Please follow the instructions below for updating the firmware:

- Configure jumper J2 to position 2-3 to activate the bootloader at start-up.
- Connect the BlueEva+S to the USB port of a PC (make sure the FTDI VCP USB to UART driver is already installed). If the BlueEva+S is already connected to the PC perform a reset using the reset button.
- Start the *BM+S_xxx_FWupdate.exe* program.

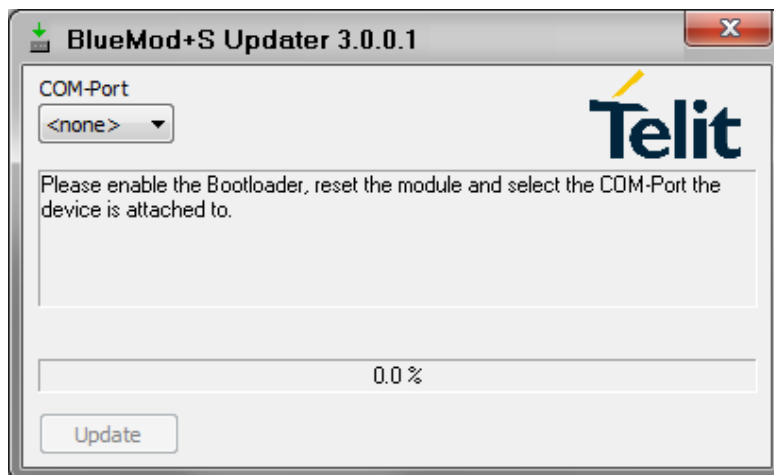

- Select the COM port the BlueEva+S is connected to and press the “Update” button.

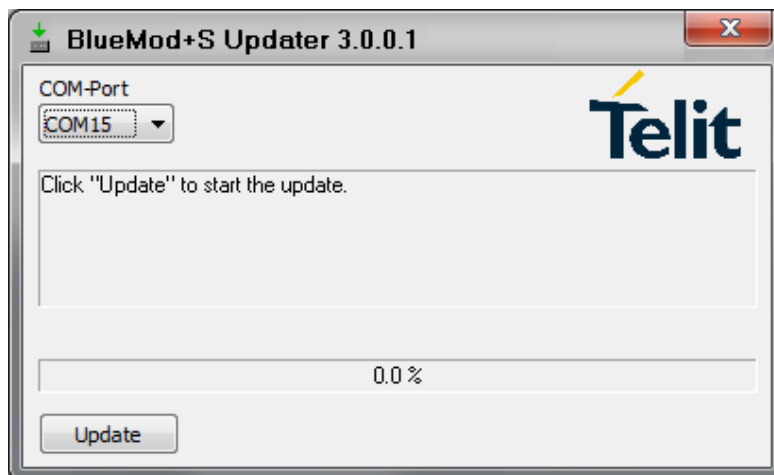

- The firmware will be uploaded.

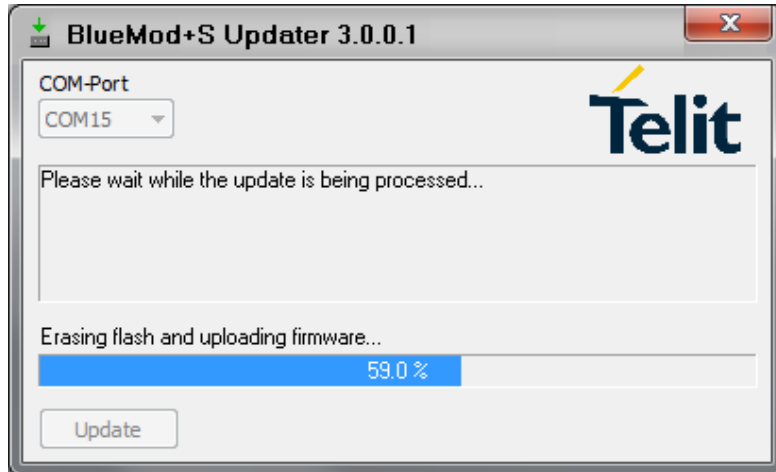

- After the update is completed click the “Finish” button.

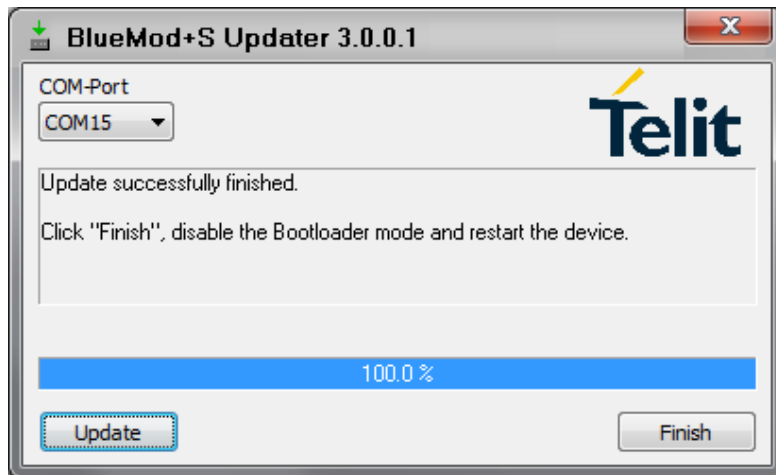

- To set back the BlueEva+S into normal operation mode, move jumper J2 to position 1-2 again and perform a reset.
- Send the AT&F command to set the factory default values.



Do not disconnect the device while the update is in progress, otherwise the update will fail and has to be repeated. In case it is not possible to update the module please contact the Telit support (e-mail: ts-srd@telit.com).



6.2. Firmware Update Over The Air (OTA)

The BlueMod+S (firmware version 2.000 and higher) supports firmware over the air update. The firmware update over the air can be performed by using the Nordic nRF ToolBox app available for iOS and Android or by using the Nordic Master Control Panel and the corresponding Nordic Bluetooth hardware.

The firmware over the air update in the BlueMod+S will be enabled with the AT commands below:

- AT+DFUMODE=2
- AT+DFUSTART

After sending the AT+DFUSTART command the BlueMod+S is visible in the air as “BM+S_DFU” (name configured with command AT+DFUNAME) for a time period of 2 minutes. If no firmware update is performed during this time the BlueMod+S will continue with normal operation.

The following chapter describes the firmware over the air update by using the Nordic nRF Toolbox app on Android.

6.3. Firmware Update Over The Air using Nordic nRF Toolbox on Android

Make sure the BlueMod+S has already activated the firmware over the air update. Open the nRF ToolBox app on the smartphone and choose “DFU”.

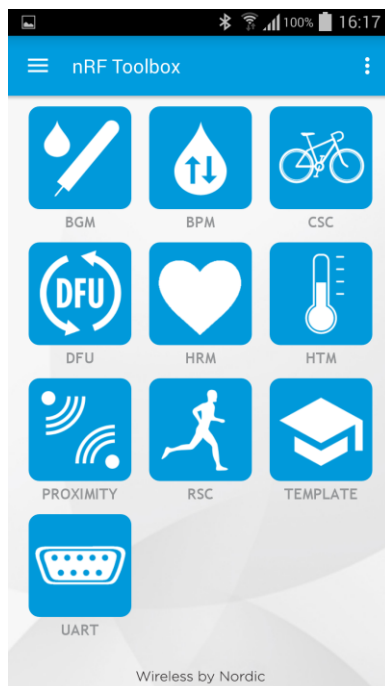

Press the button “SELECT FILE”:

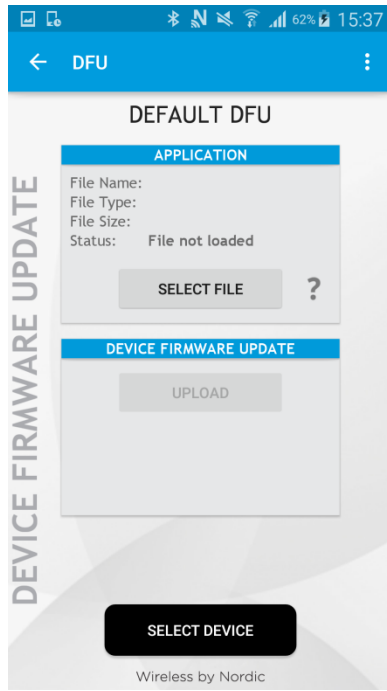

Select file type “Distribution packet (ZIP)”:

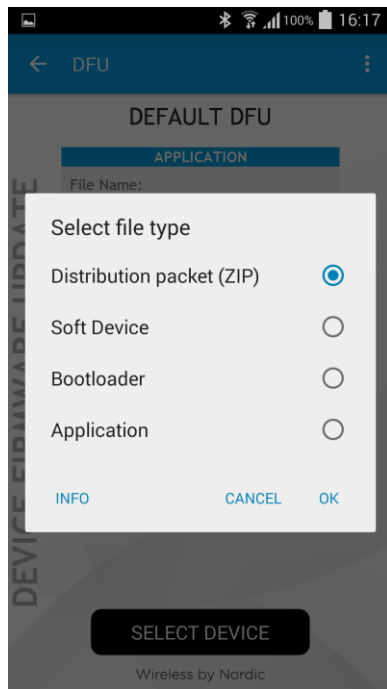

Search via file manager for the firmware package which was previously copied to the smartphone (e.g. ble_app_terminal_io_v2_003.zip in the example below):

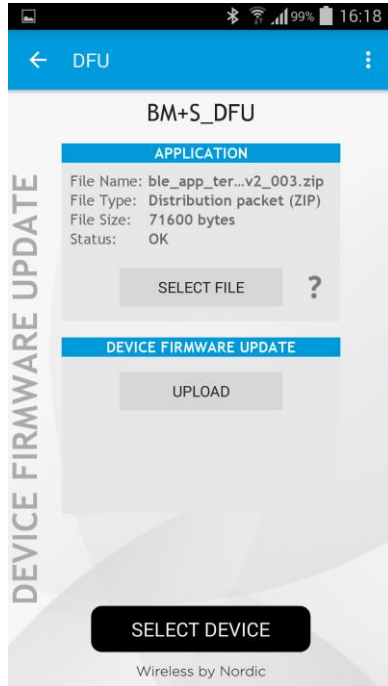

Press the button “SELECT DEVICE” and select the “BM+S_DFU” from the list of available devices:

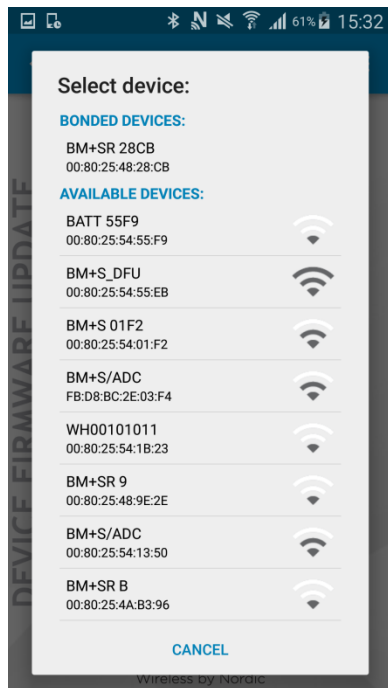

Press the “UPLOAD” button to upload the firmware package over the air to the BlueMod+S:

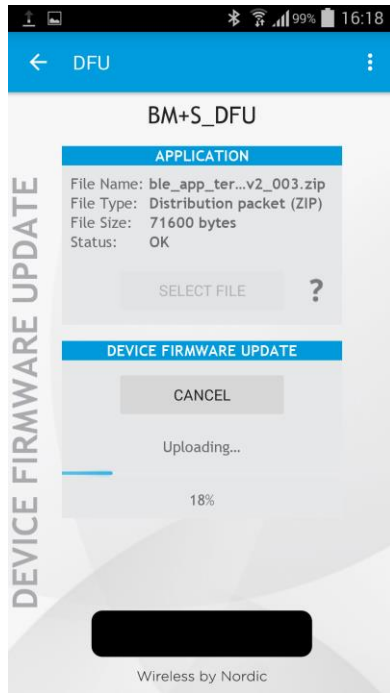

After the file was uploaded successfully the BlueMod+S will start with the new firmware.



Do not disconnect the device while the update is in progress, otherwise the update will fail and has to be repeated. In case it is not possible to update the module please contact the Telit support (e-mail: ts-srd@telit.com).



7. Document History

Revision	Date	Changes
r01	2014-04-02	First draft
r02	2014-09-11	Added chapter Firmware Update, Revised description of chapter Current Measurement
r03	2015-04-17	Adapted to V2.0
r04	2016-05-24	Telit cover page added
r05	2016-09-29	Document converted to Telit template, Changed to BlueEva+S V3 board, Added chapter Firmware Update Over The Air

