

GM862 Product Description

80272ST10019a Rev. 12 – 2010-10-20



APPLICABILITY TABLE

PRODUCT
GM862-QUAD
GM862-QUAD-PY
GM862-GPS



Contents

- 1. Introduction 7
 - 1.1. Scope 7
 - 1.2. Audience 7
 - 1.3. Contact Information, Support 7
 - 1.4. Document Organization 7
 - 1.5. Text Conventions 8
 - 1.6. Related Documents 8
 - 1.7. Document History 9
- 2. Overview 12
- 3. General Product Description 14
 - 3.1. Dimensions 14
 - 3.2. Weight 15
 - 3.3. Environmental requirements 16
 - 3.3.1. Temperature range 16
 - 3.3.2. Vibration Test (non functional) 16
 - 3.3.3. RoHS compliance 16
 - 3.4. Operating Frequency 17
 - 3.5. Transmitter output power 17
 - 3.6. Reference sensitivity 17
 - 3.7. Antennas 18
 - 3.7.1. GSM Antenna 18
 - 3.7.2. GPS Antenna 18
 - 3.8. GPS Module features 20
 - 3.8.1. GPS Specifications 20
 - 3.8.1.1. GPS Sensitivity 20
 - 3.8.1.2. GPS Average Power Consumption 21
 - 3.8.1.3. GPS Driving 21
 - 3.8.1.4. GPS NMEA 21
 - 3.8.1.5. NMEA sentences 21
 - 3.9. Supply voltage 22
 - 3.10. GSM Power consumption 22



- 3.11. Embodied Battery Charger..... 22**
- 3.12. User Interface 23**
 - 3.12.1. Speech Coding..... 23
 - 3.12.2. SIM Reader 23
 - 3.12.3. SMS..... 23
 - 3.12.4. Real Time Clock and Alarm 24
 - 3.12.5. Data/fax transmission..... 24
 - 3.12.6. Local security management 24
 - 3.12.7. Call control..... 24
 - 3.12.8. Phonebook..... 24
 - 3.12.9. Characters management 24
 - 3.12.10. SIM related functions..... 25
 - 3.12.11. Call status indication..... 25
 - 3.12.12. Automatic answer (Voice, Data or FAX) 25
 - 3.12.13. Supplementary services (SS) 25
 - 3.12.14. Acoustic signaling 25
 - 3.12.15. Buzzer Output..... 26
 - 3.12.16. RF Transmission Monitor..... 26
- 3.13. EMC..... 26**
- 3.14. Logic level specifications 26**
 - 3.14.1. Reset signal..... 26
- 3.15. Audio levels specifications 27**
- 3.16. ADC Converter..... 27**
- 3.17. Mounting the GM862 on your board..... 28**
 - 3.17.1. Interface connectors on GM862 modules 28
- 3.18. Packing system 29**
- 4. Evaluation Kit 30**
- 5. Software Features 32**
 - 5.1. Enhanced Easy GPRS Extension..... 32**
 - 5.1.1. Overview 32
 - 5.1.2. Easy GPRS definition 33
 - 5.2. Multisocket 34**
 - 5.3. Jammed Detect & Report Extension 36**
 - 5.3.1. Overview 36
 - 5.4. CMUX..... 37**
 - 5.4.1.1. Product architecture..... 37
 - 5.4.1.2. Implementation feature and limitation..... 37
 - 5.5. Easy Script Extension – Python interpreter..... 38**
 - 5.5.1. Overview 38



GM862 Product Description
80272ST10019a Rev. 12 – 2010-10-20

- 5.5.2. Python 1.5.2+ Copyright Notice..... 40
- 5.5.3. Python implementation description..... 41
- 5.5.4. Python core supported features 43
- 5.5.5. Python Build-in Custom Modules 44
- 5.6. SAP: SIM Access Profile 45**
 - 5.6.1. Product architecture 45
 - 5.6.2. Implementation feature 45
 - 5.6.3. Remote SIM Message Command Description 45
- 5.7. PFM (Premium FOTA Management) 46**
 - 5.7.1. FOTA (Firmware Over The Air)..... 47
- 6. AT Commands 48**
- 7. Conformity Assessments..... 49**
 - 7.1. GM862-QUAD: Conformity Assessment..... 51
 - 7.2. GM862-QUAD-PY: Conformity Assessment 53
 - 7.3. GM862-QUAD/QUAD-PY/GPS: RoHS certificate..... 55
 - 7.4. GM862-QUAD / QUAD-PY: FCC Equipment Authorization..... 56
 - 7.5. GM862-QUAD / QUAD-PY: IC Equipment Authorization 57
 - 7.6. GM862-GPS: Conformity Assessment 58
 - 7.7. GM862-GPS FCC Equipment Authorization 60
 - 7.8. GM862-GPS IC Equipment Authorization..... 61
- 8. SAFETY RECOMMENDATIONS 62**
- 9. Acronyms 63**



Disclaimer

The information contained in this document is the proprietary information of Telit Communications S.p.A. and its affiliates ("TELIT").

The contents are confidential and any disclosure to persons other than the officers, employees, agents or subcontractors of the owner or licensee of this document, without the prior written consent of Telit, is strictly prohibited.

Telit makes every effort to ensure the quality of the information it makes available. Notwithstanding the foregoing, Telit does not make any warranty as to the information contained herein, and does not accept any liability for any injury, loss or damage of any kind incurred by use of or reliance upon the information.

Telit disclaims any and all responsibility for the application of the devices characterized in this document, and notes that the application of the device must comply with the safety standards of the applicable country, and where applicable, with the relevant wiring rules.

Telit reserves the right to make modifications, additions and deletions to this document due to typographical errors, inaccurate information, or improvements to programs and/or equipment at any time and without notice.

Such changes will, nevertheless be incorporated into new editions of this document.

Copyright: Transmittal, reproduction, dissemination and/or editing of this document as well as utilization of its contents and communication thereof to others without express authorization are prohibited. Offenders will be held liable for payment of damages. All rights are reserved.

Copyright © Telit Communications S.p.A. 2010.



1. Introduction

1.1. Scope

The aim of this document is the description of some hardware solutions useful for developing a product with the Telit GM862 family of modules.

1.2. Audience

This document is intended for Telit customers, who are integrators, about to implement their applications using our GM862 modules.

1.3. Contact Information, Support

For general contact, technical support, to report documentation errors and to order manuals, contact Telit's Technical Support Center (TTSC) at:

TS-EMEA@telit.com
TS-NORTHAMERICA@telit.com
TS-LATINAMERICA@telit.com
TS-APAC@telit.com

Alternatively, use:

<http://www.telit.com/en/products/technical-support-center/contact.php>

For detailed information about where you can buy the Telit modules or for recommendations on accessories and components visit:

<http://www.telit.com>

To register for product news and announcements or for product questions contact Telit's Technical Support Center (TTSC).

Our aim is to make this guide as helpful as possible. Keep us informed of your comments and suggestions for improvements.

Telit appreciates feedback from the users of our information.

1.4. Document Organization

This document contains the following chapters:

[Chapter 1: "Introduction"](#) provides a scope for this document, target audience, contact and support information, and text conventions.

[Chapter 2: "Overview"](#) gives an overview of the features of the product.



[Chapter 3: “General product Description”](#) describes in details the characteristics of the product, providing information such as operating frequencies, mechanical dimensions and interfaces specifics.

[Chapter 4: “Evaluation Kit”](#) provides a brief description of the Telit Evaluation Kit (EVK2) as far as these modules are concerned.

[Chapter 5: “Software Features”](#) describes in details concepts involved in the software equipped on the modules.

[Chapter 6: “AT Commands”](#) provides specification of the AT commands supported by the modules.

[Chapter 7: “Conformity Assessment Issues”](#) provides some fundamental hints about the conformity assessment that the final application might need.

[Chapter 8: “Safety Recommendation”](#) provides some safety recommendations that must be followed by the customer in the design of applications that makes use of the modules.

1.5. Text Conventions



Danger – This information MUST be followed or catastrophic equipment failure or bodily injury may occur.



Caution or Warning – Alerts the user to important points about integrating the module, if these points are not followed, the module and end user equipment may fail or malfunction.



Tip or Information – Provides advice and suggestions that may be useful when integrating the module.

All dates are in ISO 8601 format, i.e. YYYY-MM-DD.

1.6. Related Documents

- GM862 Family Hardware User Guide, 1vv0300794
- Easy GPRS User Guide, 80000ST10028
- Easy Script in Python, 80000ST10020a



- CMUX User Guide, 30268ST10299a
- SIM Access Profile User Guide, 8000ST10029
- AT Commands Reference Guide, 80000ST10025a
- Telit EVK2 User Guide, 1vw0300704

1.7. Document History

Revision	Date	Changes
ISSUE#0	2005-04-10	initial release.
ISSUE#1	2005-10-27	Paragraphs reviewed: 1 Overview 2.1 Dimensions (GPS antenna position frozen) 2.3.1 Temperature range 2.6 Reference sensitivity 2.7.1 GSM Antenna 2.8 GPS Module features 2.8.1.1 GPS Sensitivity 2.8.1.2 GPS Consumption 2.12.9 Character management 2.12.12 Indication of network service availability 2.17 ADC Converter (GM862-GPS only) 4 AT Commands (Camera cmds, FTP cmds, GPS cmds, #NITZ, #SKIPESC, etc) 5.1.5 FTP Client
ISSUE#2	2006-01-24	Added products order codes table on page 2
ISSUE#3	2006-05-04	7.2 GM863-QUAD: RoHS certificate 7.3 GM862-QUAD-PY: RoHS certificate 2.14.1 Reset signal: unconditional reboot page 24
ISSUE#4	2006-08-04	2.7.2 GPS antenna power supply changed 2.12.16 DTMF Tones: changed minimum duration of DTMF tone 2.14 Logical level specification: voltage on buffered pins 2.14.1 Reset signal: unconditional shut down for GM862-GPS 2.15 Audio level specification 2.18 Interface connectors on GM862 modules: Added size for the Molex male connector; Added NOTE after pin table (page 33); changed value of the maximum capacitor allowed for SIMVCC line 3.1.4.1 Telit GM862 Family modules interface connector: Added size for the Molex female connector 5.4 CMUX: new paragraph dedicated to the products with the following P/N: 3990250657, 3990250658 and 3990250659 5.4 SAP: new paragraph dedicated to the products with the following P/N: 3990250657, 3990250658 and 3990250659



GM862 Product Description
80272ST10019a Rev. 12 – 2010-10-20

		<p>6 AT Commands: updated AT command list (CMUX, SAP, GPS and others: see rows in yellow) and added columns for the new products</p> <p>7.1 GM862-QUAD(P/N:3990250655): Conformity Assessment</p> <p>7.2 GM862-QUAD-PY(P/N:3990250656): Conformity Assessment</p> <p>7.11 GM862-GPS: Conformity Assessment</p>
ISSUE#5	2007-01-08	<p>added footnotes on the pages 7, 8 and 17</p> <p>2.2 Weight: changed weight values</p> <p>2.7.1 GSM Antenna: updated values of bandwidth</p> <p>2.10 GSM Power Consumption: updated values of operating current</p> <p>6.5 GM862-QUAD(P/N:3990250655) / GM862-QUAD-PY(P/N:3990250656): FCC Equipement Authorization</p> <p>6.6 GM862-QUAD(P/N:3990250655) / GM862-QUAD-PY(P/N:3990250656): IC Equipement Authorization</p> <p>6.7 GM862-QUAD(P/N:3990250659): Conformity Assessment</p> <p>6.8 GM862-QUAD-PY(P/N:3990250658): Conformity Assessment</p> <p>6.9 GM862-QUAD/QUAD-PY: RoHS Certificate</p> <p>6.11 GM862-GPS: RoHS certificate</p> <p>6.12 GM862-GPS FCC Equipment Authorization</p> <p>6.13 GM862-GPS IC Equipment Authorization</p> <p>Removed Camera option</p> <p>Revision of the whole document; content is reduced and transferred to other documents related to the product</p>
ISSUE#6	2007-06-28	<p>Introduced new disclaimer</p> <p>Updated temperature range</p> <p>2.12.12 Automatic Answer: modified</p> <p>-Added Python's new features</p> <p>-Added Multisocket paragraph</p> <p>-Introduced new GPS low power</p>
ISSUE#7	2007-11-12	<p>updated RoHS declaration</p> <p>Introduced FCC and IC certificates:</p> <p>6.10 GM862-QUAD(P/N:3990250659) / GM862-QUAD-PY(P/N:3990250658): FCC Equipment Authorization</p> <p>6.11 GM862-QUAD(P/N:3990250659) / GM862-QUAD-PY(P/N:3990250658): IC Equipment Authorization</p>
ISSUE#8	2008-01-15	<p>-Added CE mark</p> <p>-Removed information regarding phased out models from the GM862 family. (Please refer to the previous version of this document if you need information for the products with the following P/N: 3990250655)</p>



GM862 Product Description
80272ST10019a Rev. 12 – 2010-10-20

		& 3990250656)
ISSUE#9	2008-03-11	-Updated temperature specification
ISSUE#10	2008-09-18	Updated Temperature range description. Updated operating voltage range Updated P/N description Updated RoHS compliance documentation Added FOTA service description
ISSUE#11	2009-03-24	Updated power consumption in idle mode; Updated baudrate in autobauding mode. Updated supported character set Updated operational frequency Updated FOTA management service name Updated mounting on board description Updated Support contacts
ISSUE#12	2010-10-20	Applied new layout Removed EGNOS feature reference



2. Overview

The **GM862** family consist of the following modules: the **GM862-GPS**, **GM862-QUAD-PY** and **GM862-QUAD**, which combine the access to digital communication services in GSM 850, 900, DCS 1800, PCS1900 MHz networks with an additional key feature of the integrated GPS receiver (GM862-GPS only).

The **Telit GM862-GPS** includes a 20 channels GPS receiver. It provides all the features of the **GM862-QUAD** version such as Voice, Circuit Switched Data transfer, Phonebook, SMS, four bands GSM capability, hot removal sensing on board SIM Reader, GPRS Class 10 and battery charger circuitry.

Moreover, the **GM862-GPS** and **GM862-QUAD-PY** models, integrate the “*EASY SCRIPT*” functionality. This is a PYTHON engine script interpreter allowing self-controlled operations. With the EASY SCRIPT feature the **GM862-GPS** and **GM862-QUAD-PY** become a finite product, they just need your script to be run.

The **GM862** is specifically designed and developed by **Telit** for OEM usage and dedicated to portable data, voice and telematic applications, such as:

- Telemetry and Telecontrol
- Security systems
- Vending Machines
- POS terminals
- Phones and Payphones
- Return channel for digital broadcasting
- Applications, where the external application processor can be replaced by the PYTHON engine provide by GM862-GPS or GM862-QUAD-PY

Moreover, for the **GM862-GPS**:

- Automotive and Fleet Management applications
- Position reporting and tracking

All three models supports the following functionalities:

- EASY GPRS (AT driven embedded TCP/IP protocol stack)
- EASY SCAN (full GSM frequency scanning)
- JAMMING DETECT & REPORT (detect the presence of disturbing devices)
- CMUX
- SAP (SIM Access Profile)
- Multisocket



GM862 Product Description
80272ST10019a Rev. 12 – 2010-10-20

From the interface point of view, the **GM862-GPS**, **GM862-QUAD-PY** and **GM862-QUAD** provide the following features:

- Full RS232 UART, CMOS level (ASC0) interface for AT commands:
 - Auto-bauding from 1.2 up to 115.2 Kbps
 - Fixed baud rate from 300 bit/s up to 115.2 Kbps
- Two wires RS232, CMOS level (ASC1) for PYTHON debug
- SIM card interface, 3 volts and 1.8 volts
- 13 x GPIO ports (max)
- 1 x A/D converters
- 1 x buzzer output
- 1 x led status output indicator

In order to meet the competitive OEM and vertical market stringent requirements, Telit supports its customers with a dedicated Technical Support Policy with:

- **Telit Evaluation Kit EVK2** to help you to develop your application;
- a Website with all updated information available;
- a high level technical support to assist you in your development;

For more updated information concerning product Roadmap and availability, technical characteristics, commercial and other issues, please check on the Telit website www.telit.com > Products > Modules.



NOTE: Some of the performances of the **Telit GM862 modules** depend on the SW version installed on the module itself.

The **Telit GM862** SW group is continuously working in order to add new features and improve the overall performances.

The **Telit GM862 modules** are easily upgradeable by the developer using the **Telit GM862 module** Flash Programmer.

Furthermore, all the **Telit GM862 products** have the full conformity assessment against R&TTE.

Telit GM862 Module Pin-to-Pin Upgrade Policy will enable you to include in your application the new and future products of the GM862 family, allowing you to save your investments and to successfully penetrate new markets.



3. General Product Description

3.1. Dimensions

The Telit GM862-QUAD-PY and GM862-QUAD modules overall dimension are:

- Length: 43.9 mm
- Width: 43.9 mm
- Thickness: 6.9 mm
- Volume: $\cong 13 \text{ cm}^3$

The layout is shown in the following figure:

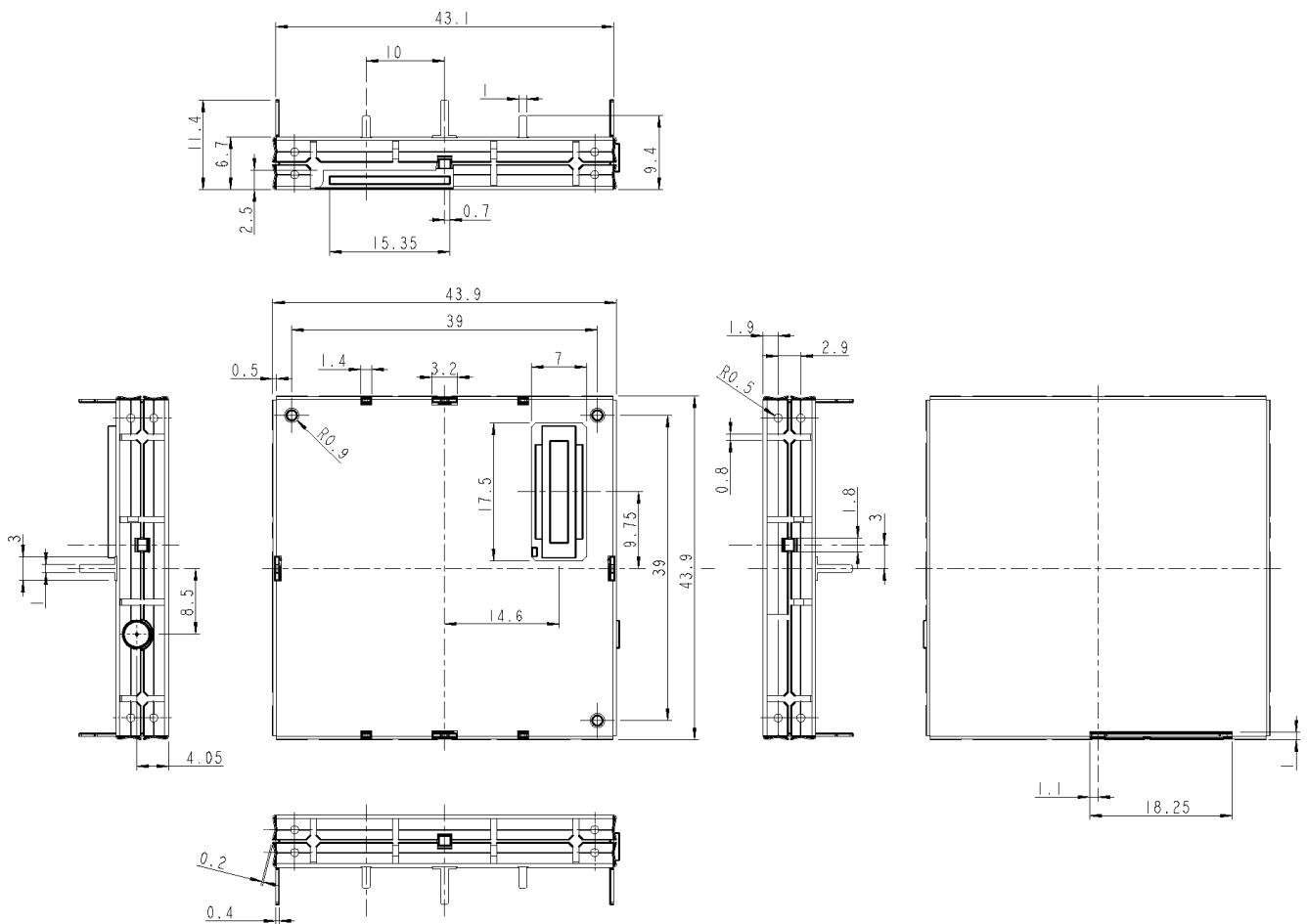

GM862 Product Description
 80272ST10019a Rev. 12 – 2010-10-20

The layout of **Telit GM862 GPS module** is shown in the following figure:

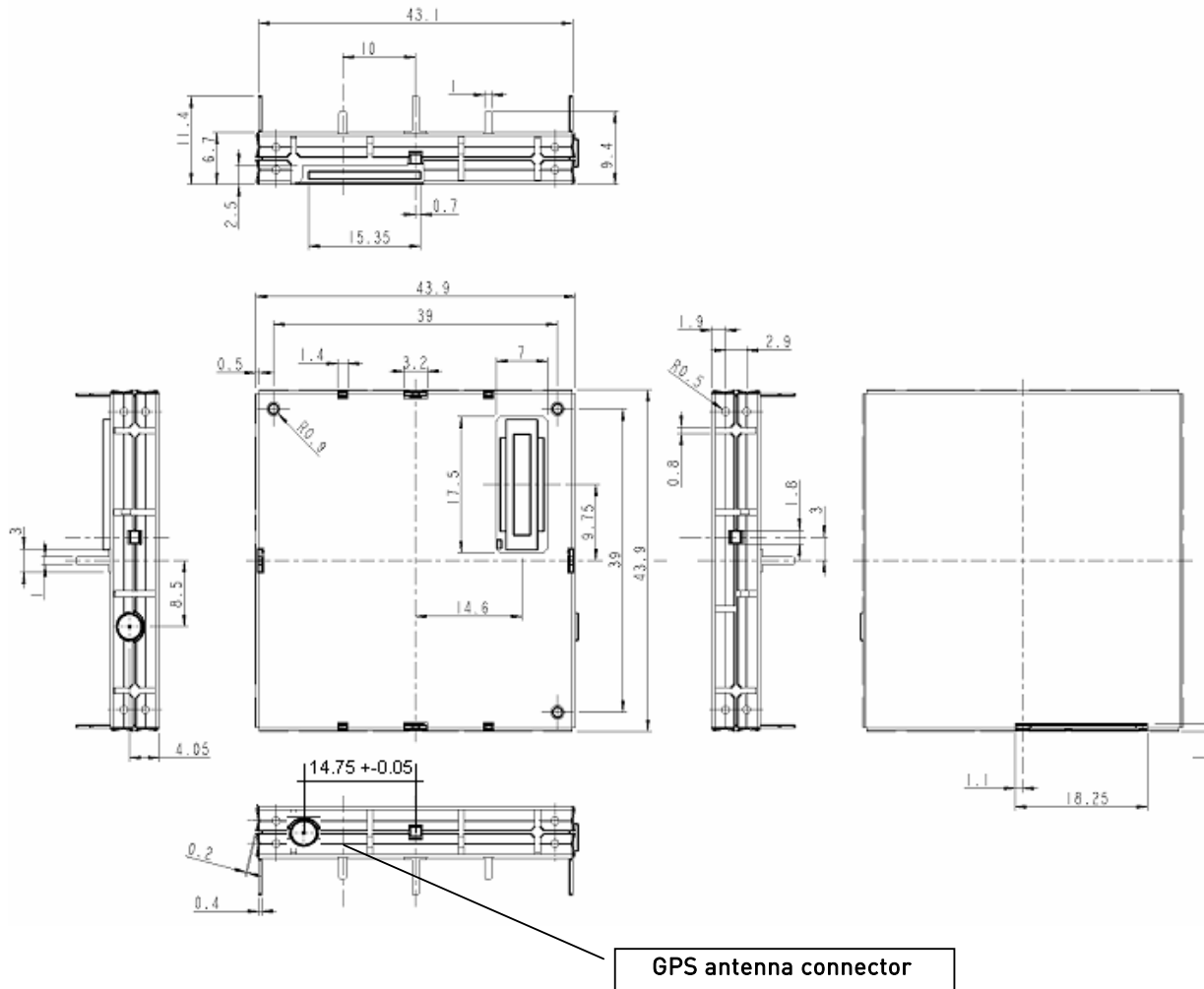

3.2. Weight

The Telit GM862 Family modules weight is:

product	weight (gr)
GM862-QUAD/QUAD-PY	18
GM862-GPS	19



3.3. Environmental requirements

The **Telit GM862 modules** are compliant with the applicable ETSI reference documentation GSM 05.05 Release1999 ETSI EN300910 V8.4.1

3.3.1. Temperature range

	GM862-QUAD / GM862-QUAD-PY	GM862-GPS	Note
Operation temperature range	-20°C ÷ +55°C	-20°C ÷ +55°C	The module is fully functional (*) in all the temperature range, and it fully meets the ETSI specifications.
	-40°C ÷ +85°C	-40°C ÷ +85°C	The module is fully functional (*) in all the temperature range. Temperatures outside the range -20°C ÷ +55°C, might slightly deviate from ETSI specifications.
Storage and non Operating Temperature Range	-40°C ÷ +85°C	-40°C ÷ +85°C	

(*) Functional: the module is able to make and receive voice calls, data calls, SMS and make GPRS traffic

3.3.2. Vibration Test (non functional)

- 10 ÷ 12Hz ASD = 1.92m 2 /s 3
- 12 ÷ 150Hz -3dB/oct

3.3.3. RoHS compliance

The GM862-QUAD /QUAD-PY and GM862-GPS are fully RoHS compliant to EU regulation.



3.4. Operating Frequency

The operating frequencies in GSM, DCS, PCS modes are conform to the GSM specifications.

Mode	Freq. TX (MHz)	Freq. RX (MHz)	Channels (ARFC)	TX - RX offset
GSM-850	824.2 – 848.8	869.2 – 893.8	128 - 251	45 MHz
E-GSM-900	890.0 - 914.8	935.0 - 959.8	0 – 124	45 MHz
	880.2 - 889.8	925.2 - 934.8	975 - 1023	45 MHz
DCS-1800	1710.2 - 1784.8	1805.2 – 1879.8	512 – 885	95 MHz
PCS-1900	1850.2 - 1909.8	1930.2 – 1989.8	512 - 810	80 MHz

3.5. Transmitter output power

GSM-850 / 900

The **Telit GM862** modules in GSM-850 / 900 operating mode are of **class 4** in accordance with the specification which determine the nominal **2W** peak RF power (**+33dBm**) on 50 Ohm.

DCS-1800 / PCS-1900

The **Telit GM862** modules in DCS-1800/PCS-1900 operating mode are of **class 1** in accordance with the specifications, which determine the nominal **1W** peak RF power (**+30dBm**) on 50 Ohm.

3.6. Reference sensitivity

GSM-850 / 900

The sensitivity of the **Telit GM862** modules according to the specifications for the class 4 GSM-850/900 portable terminals is **-107 dBm** typical in normal operating conditions.

DCS-1800 / PCS-1900

The sensitivity of the **Telit GM862** modules according to the specifications for the class 1 portable terminals DCS-1800 / PCS-1900 is **-106 dBm** typical in normal operating conditions.



3.7. Antennas

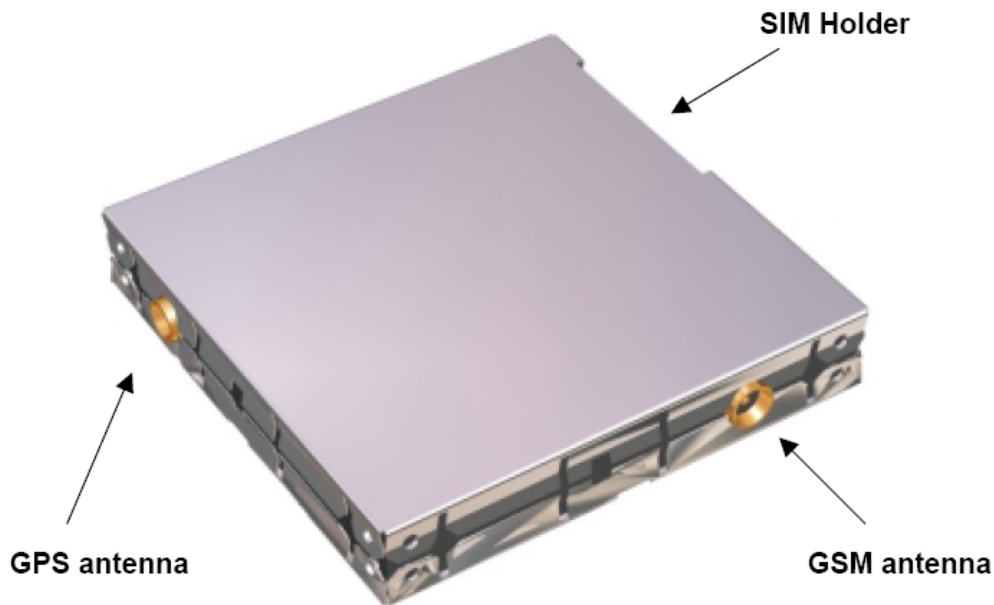

3.7.1. GSM Antenna

The antenna that the customer chooses to use, should fulfill the following requirements:

Frequency range	Depending by frequency band(s) provided by the network operator, the customer shall use the most suitable antenna for that/those band(s)
Bandwidth	80 MHz in EGSM 900, 70 MHz if GSM 850, 170 MHz in DCS, 140 MHz PCS band

For further information please refer to the GM862 Hardware User Guide.

3.7.2. GPS Antenna¹

The Telit GM862-GPS Transceiver module includes a 50 Ohm MMCX connector for the GPS antenna.

Frequency range	GPS L1 (1575.42 MHz)
Bandwidth	+/- 1.023 MHz

¹ GM862-GPS only



GM862 Product Description
80272ST10019a Rev. 12 – 2010-10-20

For further information please refer to the GM862 Hardware User Guide.



3.8. GPS Module features

The GM862-GPS includes a SiRFstarIII™ single chip GPS receiver, that supports real-time location in urban area and wherever a high sensitivity acquisition is needed. As main features of such GPS receiver, we can mention:

- High sensitivity for indoor reception, up to -159dBm (with active antenna)
- Extremely fast TTFF's at low signal levels
- Hot starts < 3 seconds
- 200,000+ effective correlators
- Supports 20-Channel GPS L1 1575.42 MHz
- Accuracy < 2.5m
- Extremely fast TTFF's at low signal levels
- GPS NMEA 0183 output format
- Date WGS-84
- Dedicated GPS AT commands
- Low power consumption⁴

3.8.1. GPS Specifications

3.8.1.1. GPS Sensitivity

Time to first fix	
Hot start	Autonomous <3s
Warm start	Autonomous <35s
Cold start	Autonomous <35s
Sensitivity ²	
Tracking	up to -159 dBm

² NOTE: sensitivity is affected by the type of active GPS antenna used in the application.



3.8.1.2. GPS Average Power Consumption

The typical current consumption of the GPS part of the Telit **GM862-GPS** modules is:

	GM862-GPS
Operating current	55mA, including 35mA GPS for the GPS hardware and 20 mA for the antenna LNA

3.8.1.3. GPS Driving

The GPS functions are driven from the GSM BB processor through a dedicated AT command set available in a separately specification.

3.8.1.4. GPS NMEA

The GPS data stream (NMEA 0183 format) is also available on the connector (pins 35 and 41 : TX_GPS and RX_GPS) in RS232 format (8N1, 4800 bps (9600, 19200, 38400, and 57600 bps are available too).

3.8.1.5. NMEA sentences

The following GPS sentences are available:

GGA - Global positioning system fix data (provides 3D location and accuracy data)

VTG - Course over ground and ground speed

GSA - GPS DOP and active satellites

RMC - Recommended Minimum Specific GPS Data

GLL - Geographic Latitude and Longitude



3.9. Supply voltage

The external power supply must be connected to VBATT signal (see Hardware User Guide) and must fulfil the following requirements:

POWER SUPPLY		
	SW rel. 7.02.xx4 or older	SW rel. 7.03.x00 or newer
Nominal Supply Voltage	3.8 V	3.8 V
Max Supply Voltage	4.2 V	4.5 V
Supply voltage range	3.4 V - 4.2 V	3.22 V - 4.5 V



NOTE: Operating voltage range must never be exceeded; min/max voltage requirements and peak current supply should be fulfilled.

3.10. GSM Power consumption

The typical current consumption of the **Telit GM862 Family modules** are:

Power off current (typical)	< 26 μ A;
Stand-by current (GSM Idle)	< 17 mA (< 2.6 mA using command AT+CFUN)
Operating current in voice channel	< 200 mA @ worst network conditions
Operating current in GPRS class 10	< 370 mA @ worst network conditions

The total power consumption of GM862-GPS is the sum of the consumptions of GSM and GPS part.

3.11. Embodied Battery Charger

The battery charger is suited for 3.7V Li-Ion rechargeable battery (suggested capacity 500-1000mA). The Charger needs only a CURRENT LIMITED power source input and charges the battery directly through VBATT connector pins.

Battery charger input pin	CHARGE
Battery pins	VBATT, GND
Battery charger input voltage min	5.0 V
Battery charger input voltage typical	5.5 V
Battery charger input voltage max	7.0 V
Battery charger input current max	400mA
Battery type	Li-Ion rechargeable





NOTE: If embodied battery charger is used, then a LOW ESR capacitor of at least 100 μ F must be mounted in parallel to VBATT pin.

NOTE: when power is supplied to the CHARGE pin, a battery must always be connected to the VBATT pins.

3.12. User Interface

The user interface is managed by AT commands specified on the ITU-T V.250, GSM 07.07 and 07.05 specification.

3.12.1. Speech Coding

The Telit GM862 voice codec supports the following rates:

- Half Rate.
- Full rate,
- Enhanced Full Rate
- Adaptive Multi Rate

3.12.2. SIM Reader

The Telit GM862-QUAD, GM862-QUAD-PY and GM862-GPS support phase 2 GSM11.14 - SIM 1.8V and 3V. For 5V SIM operation an external level translator can be added.

The Telit GM862-QUAD, QUAD-PY and GPS have an internal built-in SIM card reader that allows also hot removal of the SIM sensing. Therefore, the SIM can be extracted and reinserted while the module is still on, so there's no need for an external SIM housing.



NOTE: the hot removal of the SIM sensing is not supported during power saving mode (+CFUN: 5)

3.12.3. SMS

The Telit GM862 Family modules supports the following SMS types:

- Mobile Terminated (MT) class 0 – 3 with signalling of new incoming SMS, SIM full, SMS read
- Mobile Originated class 0 – 3 with writing, memorize in SIM and sending



- Cell Broadcast compatible with CB DRX with signalling of new incoming SMS.

3.12.4. Real Time Clock and Alarm

The **Telit GM862 Family modules** supports the Real Time Clock and Alarm functions through AT commands, furthermore an alarm output pin (GPIO6) can be configured to indicate the alarm with a hardware line output.

3.12.5. Data/fax transmission

As for the data and fax capabilities, the **GM862-QUAD,QUAD-PY** and **GPS** support the following:

	GM862-QUAD	GM862-QUAD-PY	GM862-GPS
GPRS Class 8, MS Class 8	•	•	•
GPRS Class 10, MS Class 8.	•	•	•
CSD up to 14.4 Kbps	•	•	•
Fax service, Class 1 Group 3	•	•	•

3.12.6. Local security management

With lock of Subscriber Identity module (SIM), and security code request at power-up.

3.12.7. Call control

Call cost control function.

3.12.8. Phonebook

Function available to store the telephone numbers in SIM memory.
Capability depends on SIM version/memory

3.12.9. Characters management

The GM862 supports:

- the IRA characters set (International Reference Alphabet), in TEXT and PDU mode;
- UCS2;
- GSMDefaults.



3.12.10. SIM related functions

The activation and deactivation of the numbers stored in phone book are supported, FDN, ADN and PINs too. The extension at the PIN2 for the PUK2 insertion capability for lock condition is supported too.

3.12.11. Call status indication

The call status indication by AT commands is supported.

3.12.12. Automatic answer (Voice, Data or FAX)

After a specified number of rings, the module will automatically answer. The user can set the number of rings by means of the command `ATSO=<n>`.

3.12.13. Supplementary services (SS)

- Call Barring,
- Call Forwarding,
- Calling Line Identification Presentation (CLIP),
- Calling Line Identification Restriction (CLIR),
- Call Waiting, other party call Waiting Indication,
- Call Hold, other party Hold / Retrieved Indication,
- Closed User Group supplementary service (CUG),
- Advice of Charge,
- Unstructured SS Mobile Originated (MO)

3.12.14. Acoustic signaling

The acoustic signalling of the **GM862** on the selected acoustic device are the following:

- Call waiting;
- Ringing tone;
- SMS received tone;
- Busy tone;
- Power on/off tone;
- Off Hook dial tone;
- Congestion tone;
- Connected tone;
- Call dropped;
- No service tone;
- Alarm tone.



3.12.15. Buzzer Output

The General Purpose I/O pin GPIO7 can be configured to output the BUZZER output signal, with only an external Mosfet/transistor and a diode a Buzzer can be directly driven. The ringing tone and the other signalling tones can be redirected to this Buzzer output with a specific AT command.

3.12.16. RF Transmission Monitor

As alternate function of the GPIO5, the GM862-GPS, QUAD-PY and QUAD provide the RF transmission monitor. When the alternate function is activated, the pin of GPIO5 changes to HIGH every time the module transmits an RF signal and remains HIGH for the duration of the transmission sequence, i.e. it does not change with every GSM signal burst.

3.13. EMC

Compliant to EN301-489-1 and EN301-489-7 and all applicable GSM Specifications. Compliant to Directive 1999/05/CE.

3.14. Logic level specifications

Where not specified, all the interface circuits work at 2.8V CMOS logic levels. To get more detailed information about the logical level specifications used in the **Telit GM862** interface circuits please consult the Hardware User Guide.

3.14.1. Reset signal

RESET is used to reset the **GM862 modules**. Whenever this signal is pulled low, the GM862 is reset. When the device is reset it stops any operation. After the release of the reset GM862-QUAD and GM862-QUAD-PY are unconditionally rebooted, while GM862-GPS is unconditionally shut down, without doing any detach operation from the network where it is registered to. This behaviour is not a proper shut down because any GSM device is requested to issue a detach request on turn off. For this reason the Reset signal must not be used to normally shutting down the device, but only as an emergency exit in the rare case the device remains stuck waiting for some network response.



NOTE: do not use this signal to power off the **GM862**. Use the ON/OFF signal (Pin 17 of S0301) to perform this function or the AT#SHDN command.



3.15. Audio levels specifications

The audio path of the **Telit GM862 module** is organized into two main paths:

- internal path (called also MT)
- external path (called also HF)

These two paths are meant respectively for handset and headset/hands free use. The **Telit GM862 Family modules** has a built in echo canceller and a noise suppressor, tuned separately for the two audio paths; for the internal path the echo canceller parameters are suited to cancel the echo generated by a handset, while for the external audio path they are suited for a hands free use.

For more information on the audio refer to the Hardware User Guide.

3.16. ADC Converter

The on board ADCs are 11-bit converter. They are able to read a voltage level in the range of 0÷2 volts applied on the ADC pin input, and convert it into 11 bit word.

	Min	Max	Units
Voltage range	0	2	Volt
AD conversion	11	11	bits
Resolution	1	1	mV
Sampling rate	1 (idle)	60 (on traffic)	secs



3.17. Mounting the GM862 on your board

3.17.1. Interface connectors on GM862 modules

The Telit GM862 Family modules has the following interfaces:

- GSM antenna connector
- Board To Board Interface connector
- SIM Card Reader
- GPS antenna connector (GM862-GPS only)

The Telit GM862 Family modules board to board connector is a CSTP 50 pin vertical SMD Molex 52991-0508 (male).

Its pin-out (down view) is:

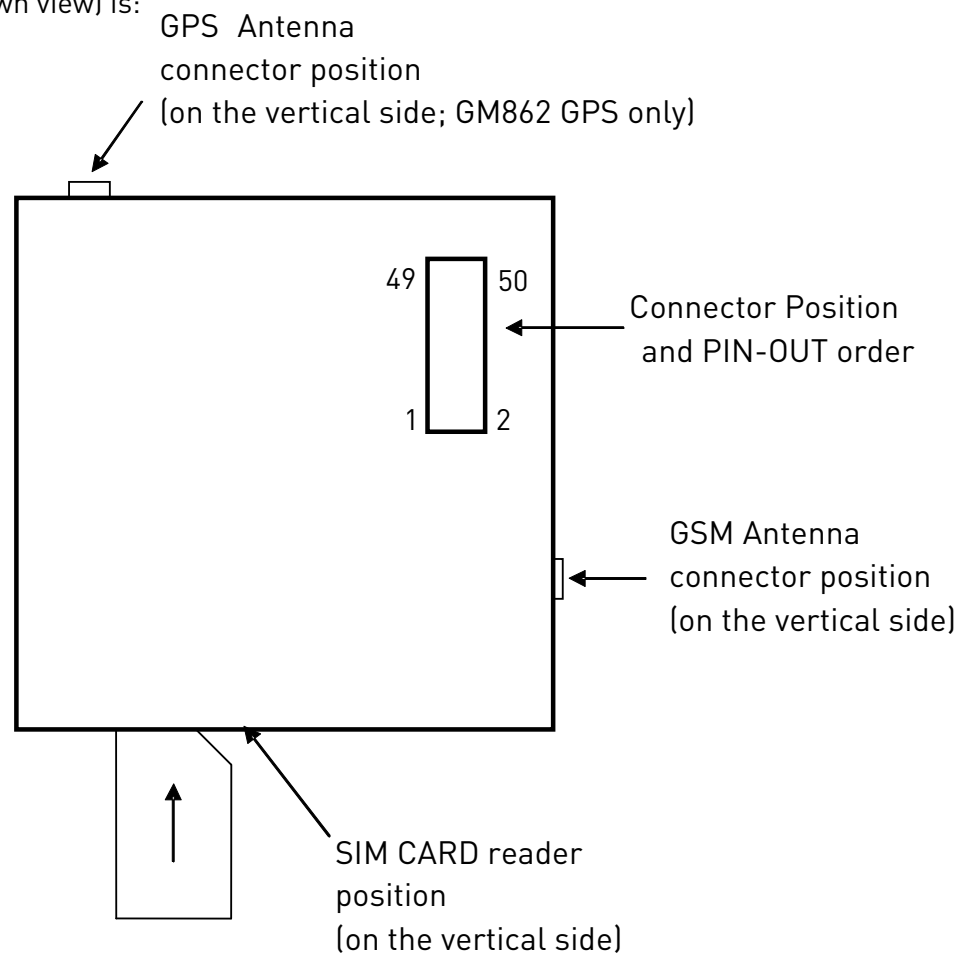



NOTE:

For detailed information please refer to Hardware User Guide

3.18. Packing system

The Telit GM862 are packaged on trays of 10 pieces each.

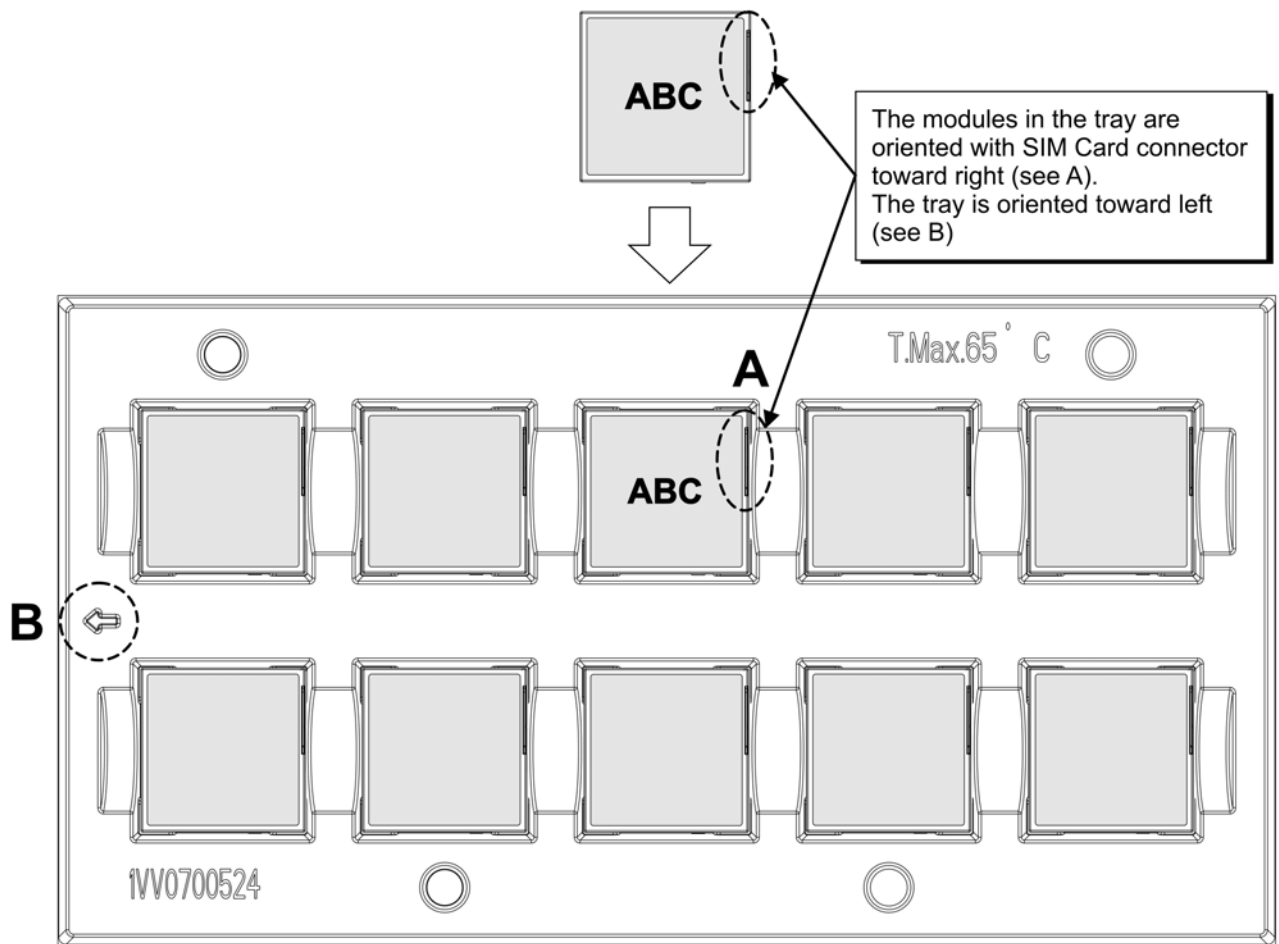

WARNING:

These trays can withstand at the maximum temperature of 65° C.



4. Evaluation Kit

In order to assist you in the development of your **Telit GM862 Family modules** based application, Telit can supply an **Evaluation Kit** that interfaces the **Telit GM862 Family modules** directly with appropriate power supply, SIM card housing, RS 232 serial port level translator and USB, direct UART connection, Handset, Earphone and Hands-free (car kit) audio, antenna and all General Purpose I/O ports of **Telit GM862 Family modules** supported in a dedicated connector.

The EVK provides a fully functional solution for a complete data/phone application. The standard serial RS232 9 pin connector placed on the **Evaluation Kit** allows the connection of the EVK system with a PC or other DTE. The development of the applications utilizing the **Telit GM862 Family modules** must present a proper design of all the interfaces towards and from the module (e.g. power supply, audio paths, level translators), otherwise a decrease in the performances will be introduced or, in the worst case, a wrong design can even lead to an operating failure of the module.

In order to assist the hardware designer in his project phase, the EVK board presents a series of different solutions, which will cover the most common design requirements on the market, and which can be easily integrated in the OEM design as building blocks or can be taken as a starting points in developing a specific one.

On the Board there are three different power supply inputs, that embrace a wide range of applications, from the automotive +12V / +24V nominal input to the stand alone battery powered device.



GM862-Evaluation Kit



GM862 Product Description
80272ST10019a Rev. 12 – 2010-10-20

For a detailed description of the **Telit GM862 Evaluation Kit** refer to the documentation provided with the Telit GM862 Hardware User Guide and EVK2 User Manual.



5. Software Features

5.1. Enhanced Easy GPRS Extension

5.1.1. Overview

The Easy GPRS feature allows the models **Telit GM862-QUAD,QUAD-PY** and **GPS** user to contact a device in internet and establish with it a raw data flow over the GPRS and Internet networks.

This feature can be seen as a way to obtain a "virtual" serial connection between the Application Software on the Internet machine involved and the controller of the **Telit GM862** module, regardless of all the software stacks underlying.

An example of the protocol stack involved in the devices is reported:

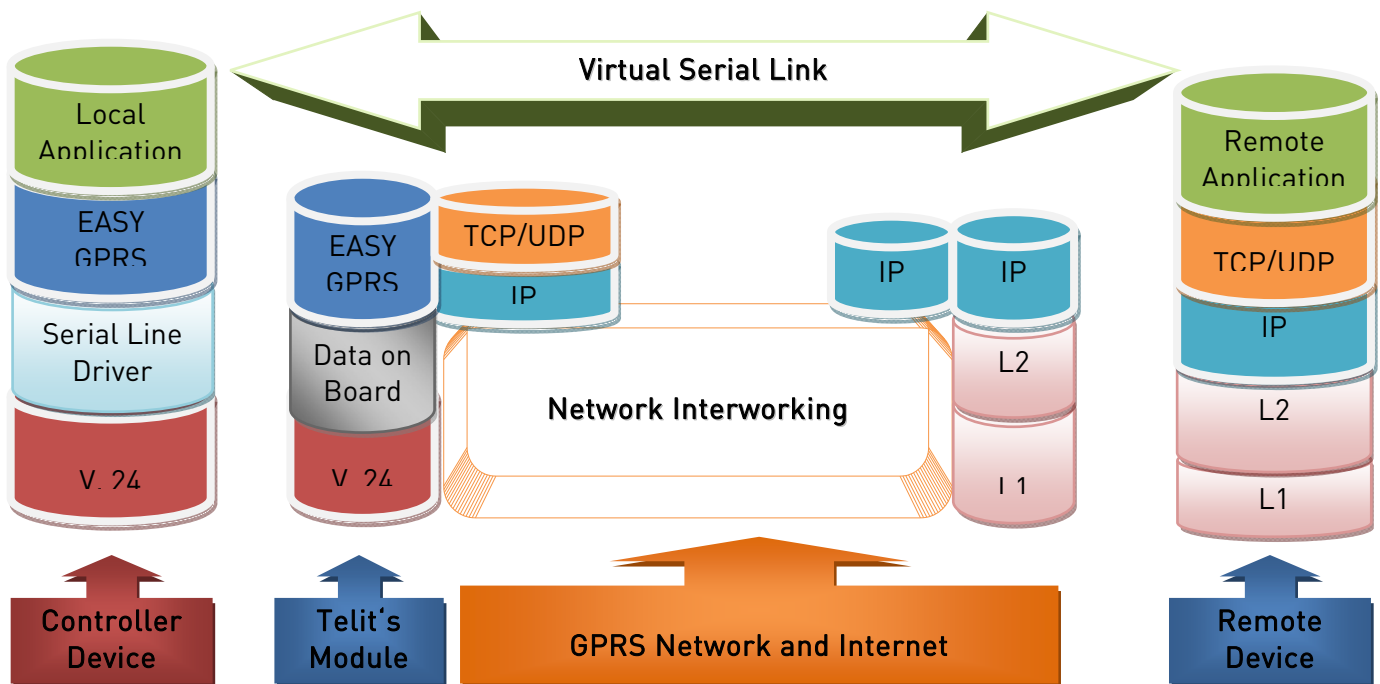

This particular implementation allows to the devices interfacing to the **Telit GM862** module the use of the GPRS and Internet packet service without the need to have an internal TCP/IP stack since this function is embedded inside the module. The Easy GPRS overcomes some of the known limitations of the previous implementation and implements some new features such as:



- Keep the GPRS context active even after the closing of a socket, allowing the application to keep the same IP address;
- Also Mobile terminated (incoming) connections can be made, now it is possible to receive incoming TCP connection requests;
- A new internal firewall has been implemented in order to guarantee a certain level of security on internet applications.

5.1.2. Easy GPRS definition

The Easy GPRS feature provides a way to replace the need of an Internet TCP/IP stack at the terminal equipment side. The steps that will be required to obtain a virtual serial connection (that is actually a socket) to the Internet peer are:

- configuring the GPRS Access
- configuring the embedded TCP/IP stack behaviour
- defining the Internet Peer to be contacted
- request the GPRS and socket connections to be opened (host is connected)
- exchange raw data
- close the socket and GPRS context

All these steps are achieved through AT commands.

As for common modem interface, two logical status are involved: command mode and data traffic mode.

- In Command Mode (CM), some AT commands are provided to configure the Data Module Internet stack and to start up the data traffic.
- In data traffic mode (Socket Mode, SKTM), the client can send/receive a raw data stream which will be encapsulated in the previously configured TCP / IP packets which will be sent to the other side of the network and vice versa. Control plane of ongoing socket connection is deployed internally to the module.

For more detailed information regarding GPRS please consult Easy GPRS User Guide and AT Commands Reference Guide.



5.2. Multisocket

New functionality of the Telit modules, multisocket is an extension of Telit Easy GPRS feature, which allows the user to have two contexts activated (that means two different IP address), more than one socket connection (with a maximum of 6) and simultaneous FTP client service.

The basic idea of multisocket is the possibility of suspend a socket connection with the escape sequence +++.

With IP Easy we can use a SKTD to open a socket connection and go online. After online activities we use +++ sequence to close the connection (see the figure below).

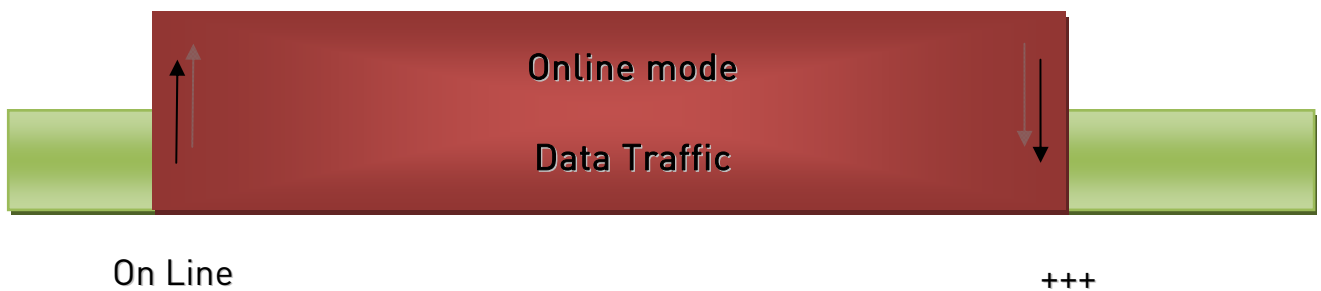

Where the green part represents the module command mode while the red part is the online mode.

Now, the online mode can be suspended with the escape sequence by using the multisocket feature. During suspend mode the data received by the socket will be buffered. These data will be displayed after socket resumption, as shown in the figure below:



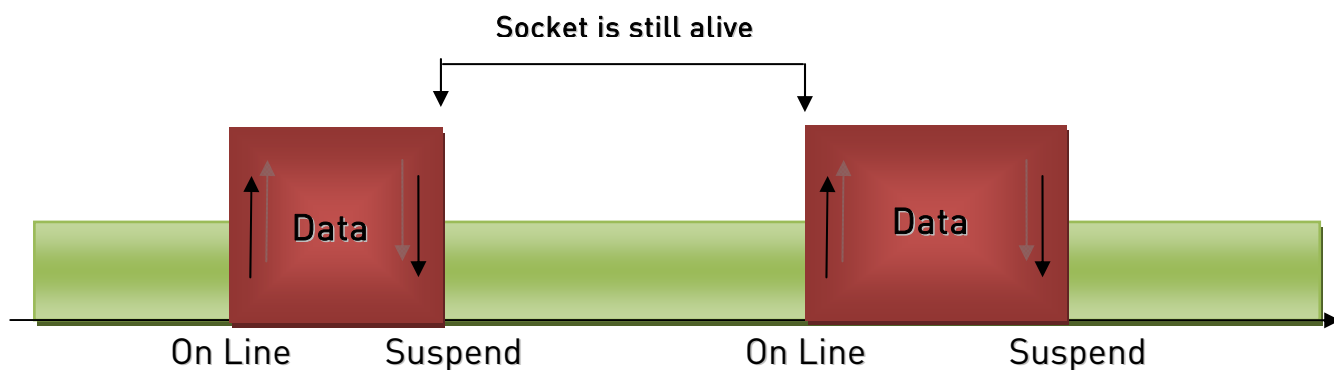

This new feature allows the user to switch between online mode and command mode without closing the connection and eventually opening another socket (or resuming the suspended one) or FTP connection.

Another feature is the possibility to associate any socket connection to a specific context, this means that we can use different IP addresses for the connections (max 2). Socket identifier is called Connection Id (selects which socket we want to use from 1 up to 6) and every Connection Id is associated to a context.

For more detailed information please consult Easy GPRS User Guide.



5.3. Jammed Detect & Report Extension

5.3.1. Overview

The Jammed Detect & Report feature allows a **Telit GM862-QUAD, QUAD-PY and GPS modules** to detect the presence of a disturbing device such as a Communication Jammer and give indication to the user and/or send a report of that to the network.

This feature can be very important in alarm, security and safety applications that rely on the module for the communications. In these applications, the presence of a Jammer device can compromise the whole system reliability and functionality and therefore shall be recognized and reported either to the local system for countermeasure actions or to the network providing remote actions.

An example scenario could be an intrusion detection system that uses the module for sending the alarm indication for example with an SMS to the system owner, and a thief incomes using a Jammer to prevent any communication between the GSM module and the network.

In such a case, the module detects the Jammer presence even before the break in and can trigger an alarm siren, other communication devices (PSTN modem) or directly report this condition to the network that can provide further security services for example sending SMS to the owner or police. Obviously this last service depends also from network infrastructure support and it may not be supported by some networks.



5.4. CMUX

CMUX (Converter-Multiplexer) is a multiplexing protocol implemented in the Telit module that can be used to send any data, SMS, fax, TCP data.

5.4.1.1. Product architecture

The Multiplexer mode enables one serial interface to transmit data to four different customer applications. This is achieved by providing four virtual channels using a Multiplexer (Mux).

This is especially advantageous when a fax/data/GPRS call is ongoing. Using the Multiplexer features, e.g. controlling the module or using the SMS service can be done via the additional channels without disturbing the data flow; access to the second UART is not necessary.

Furthermore, several accesses to the module can be created with the Multiplexer. This is of great advantage when several independent electronic devices or interfaces are used.

To access the three virtual interfaces, both the GSM engine and the customer application must contain Mux components, which communicate over the multiplexer protocol.

In Multiplexer mode, AT commands and data are encapsulated into packets. Each packet has channel identification and may vary in length.

5.4.1.2. Implementation feature and limitation

- 7.10 CMUX Basic Option used
- CMUX implementation support four full DLCI (Serial Port)
- Every CMUX instance has its own user profile storage in NVM
- Independent setting of unsolicited message.
- In case of GPS product one serial port can be dedicated to NMEA output.
- Every CMUX instance has its own independent flow control



NOTE: More details about the Multiplexer mode are available in the Cmux Product Specification



5.5. Easy Script Extension - Python interpreter

5.5.1. Overview



NOTE:

This feature is available only on models **GM862-QUAD-PY** and **GM862-GPS**.

The Easy Script Extension is a feature that allows driving the modem "internally", writing the controlling application directly in a nice high level language: Python. The Easy Script Extension is aimed at low complexity applications where the application was usually done by a small microcontroller that managed some I/O pins and the GM862-QUAD-PY and GM862-GPS through the AT command interface. A schematic of such a configuration can be:

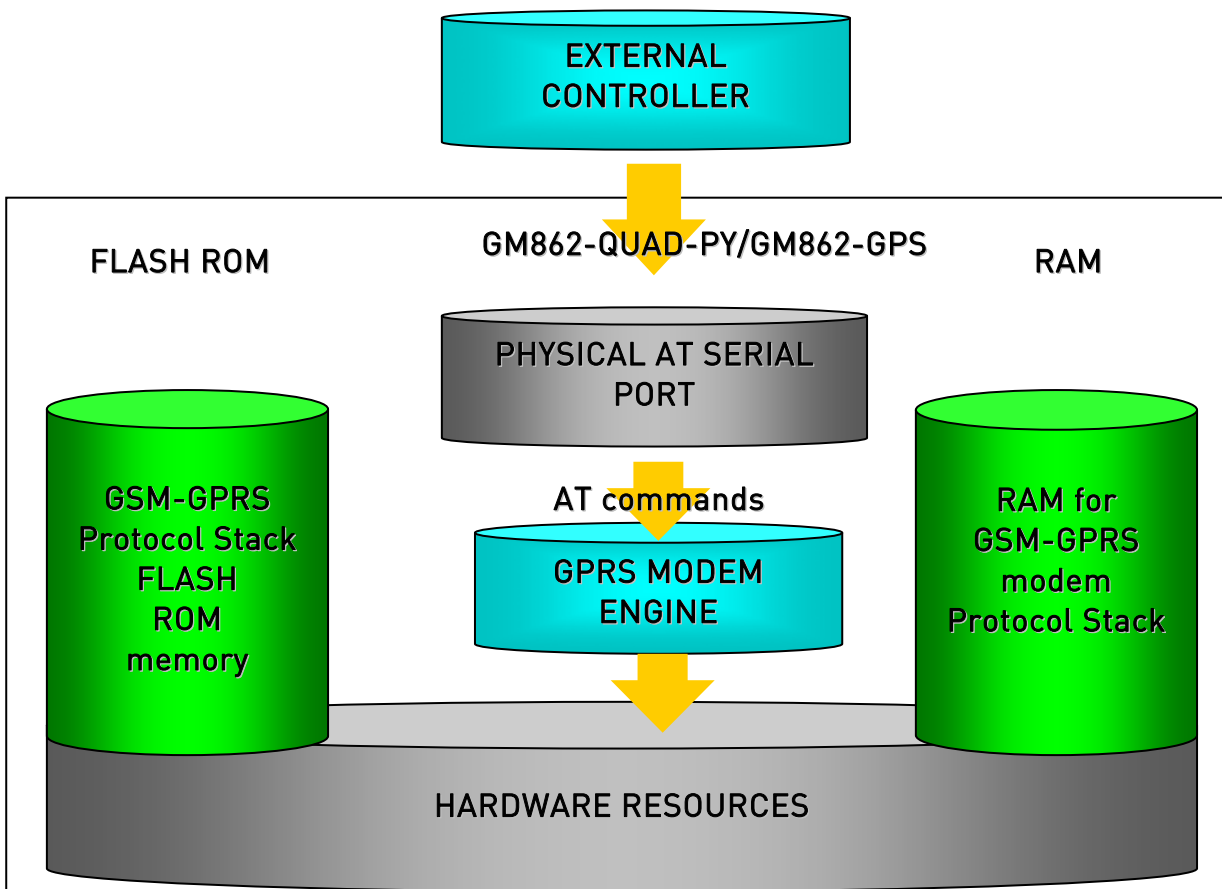

In order to eliminate this external controller, and further simplify the programming of the sequence of operations, inside the GM862-QUAD-PY / GM862-GPS it is included:

- Python script interpreter engine v. 1.5.2+
- around 3MB of Non Volatile Memory room for the user scripts and data
- 1.2 MB RAM reserved for Python engine usage

A schematic of this approach is:

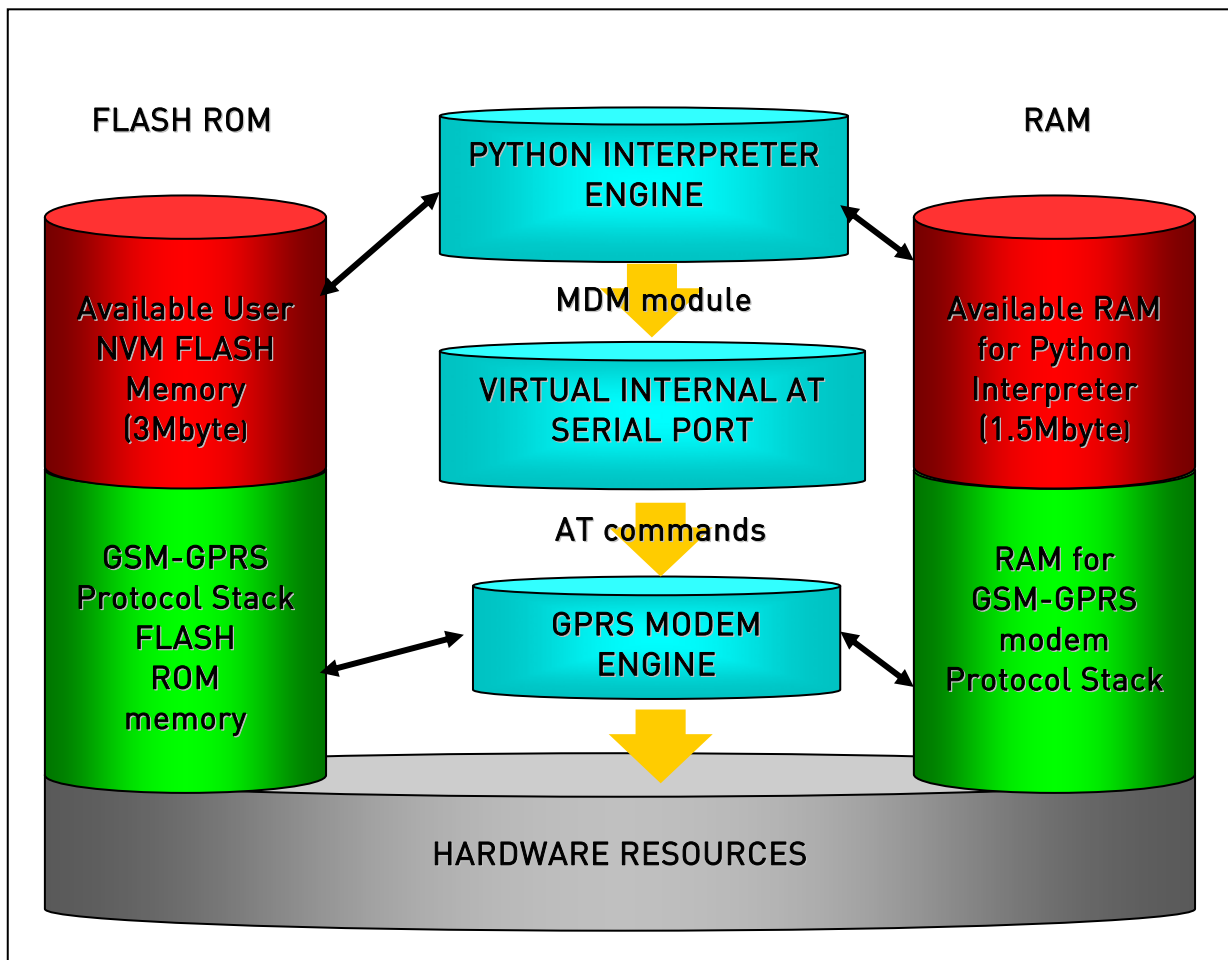
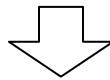

5.5.2. Python 1.5.2+ Copyright Notice

The Python code implemented into the **Telit module** is copyrighted by Stichting Mathematisch Centrum, this is the license:

Copyright © 1991-1995 by Stichting Mathematisch Centrum, Amsterdam, The Netherlands.

All Rights Reserved

Copyright (c) 1995-2001 Corporation for National Research Initiatives; All Rights Reserved.

Copyright (c) 2001, 2002, 2003, 2004 Python Software Foundation; All Rights Reserved.

Copyright (c) 2001-2008 Python Software Foundation; All Rights Reserved.

All Rights Reserved are retained in Python.

Permission to use, copy, modify, and distribute this software and its documentation for any purpose and without fee is hereby granted, provided that the above copyright notice appear in all copies and that both that copyright notice and this permission notice appear in supporting documentation, and that the names of Stichting Mathematisch Centrum or CWI or Corporation for National Research Initiatives or CNRI not be used in advertising or publicity pertaining to distribution of the software without specific, written prior permission.

While CWI is the initial source for this software, a modified version is made available by the Corporation for National Research Initiatives (CNRI) at the Internet address <ftp://ftp.python.org>.

STICHTING MATHEMATISCH CENTRUM AND CNRI DISCLAIM ALL WARRANTIES WITH REGARD TO THIS SOFTWARE, INCLUDING ALL IMPLIED WARRANTIES OF MERCHANTABILITY AND FITNESS, IN NO EVENT SHALL STICHTING MATHEMATISCH CENTRUM OR CNRI BE LIABLE FOR ANY SPECIAL, INDIRECT OR CONSEQUENTIAL DAMAGES OR ANY DAMAGES WHATSOEVER RESULTING FROM LOSS OF USE, DATA OR PROFITS, WHETHER IN AN ACTION OF CONTRACT, NEGLIGENCE OR OTHER TORTIOUS ACTION, ARISING OUT OF OR IN CONNECTION WITH THE USE OR PERFORMANCE OF THIS SOFTWARE.



5.5.3. Python implementation description

Python scripts are text files stored in NVM inside the **Telit GM862-QUAD-PY** and **GM862-GPS**. There's a file system inside the module that allows to write and read files with different names on one single level (no subdirectories are supported).

Attention: it is possible to run only one Python script at the time.

The Python script is executed in a task inside the **Telit module** at the lowest priority, making sure this does not interfere with GSM/GPRS normal operations. This allows serial ports, protocol stack etc. to run independently from the Python script.

The Python script interacts with the **Telit module** functionality through four build-in interfaces.

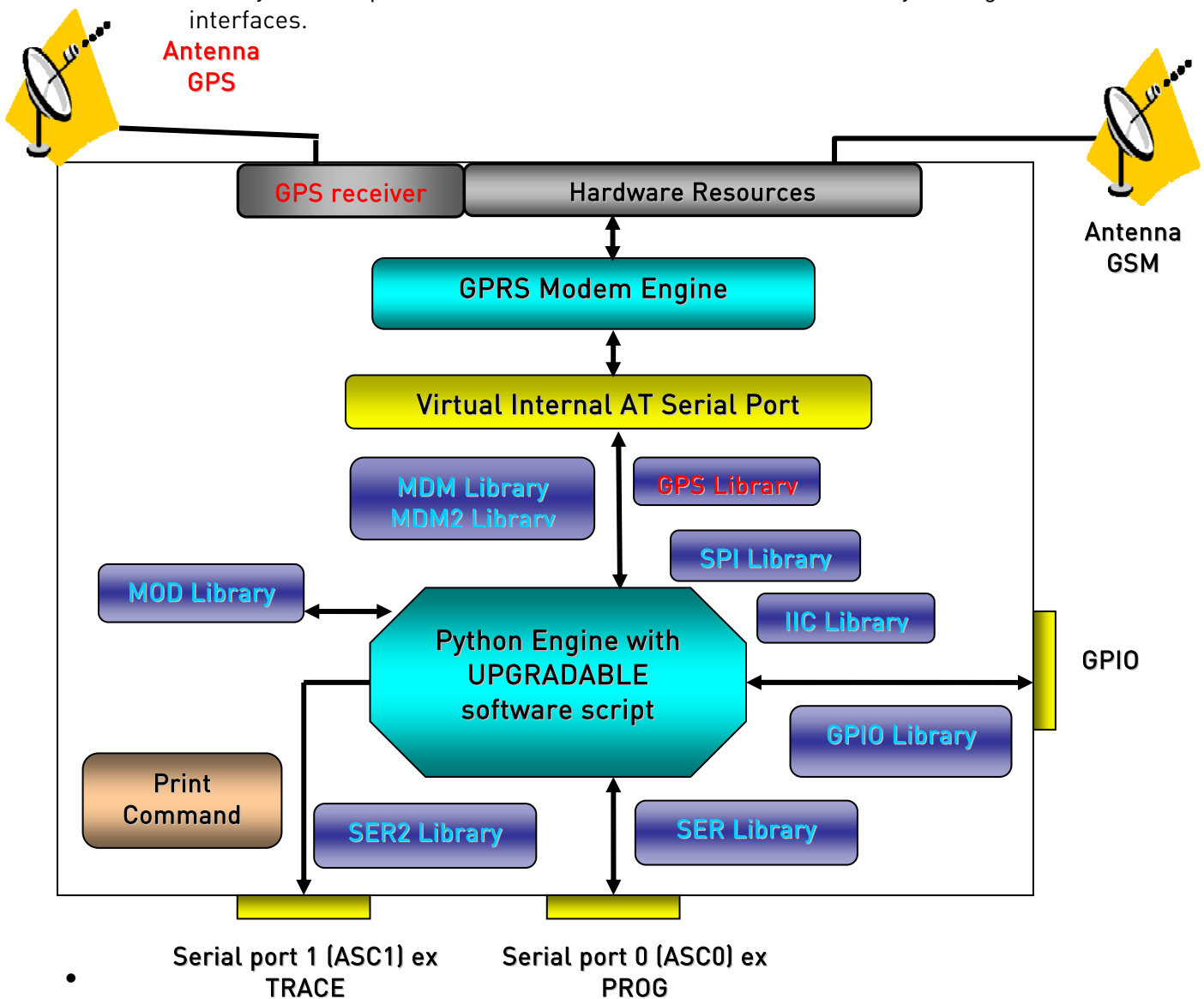



NOTE: Antenna GPS, GPS receiver and GPS Library are available exclusively for GPS module **GM862-GPS**. Moreover SER2 Library can not be used by the GPS modules since their TRACE port is not available.

- **The MDM interface** is the most important one. It allows Python script to send AT commands, receive responses and unsolicited indications, send data to the network and receive data from the network during connections. It is quite the same as the usual serial port interface in the **Telit module**. The difference is that this interface is not a real serial port but just an internal software bridge between Python and mobile internal AT command handling engine. All AT commands working in the **Telit module** are working in this software interface as well. Some of them have no meaning on this interface, such as those regarding serial port settings. The usual concept of flow control keeps its meaning over this interface, but it's managed internally.
- **The MDM2 interface** is the second interface between Python and mobile internal AT command handling. It is used to send AT commands from Python script to mobile and receive AT responses from mobile to Python script when the classic MDM built-in module already in use.
- **The SER interface** allows Python script to read from and write to the *real* physical serial port ASC0, that is usually used to send the AT commands to the module, for example to read information from external device. When Python is running this serial port is free to be used by Python script because it is not used as AT command interface since the AT parser is mapped into the internal virtual serial port. No flow control is available from Python on this port.
- **The SER2 interface** allows Python script to read from and write to the *real* physical serial port ASC1, that is usually available for trace and debug.
- **The GPIO interface** allows Python script to handle general purpose input output faster than through AT commands, skipping the command parser and going directly to control the pins.
- **The MOD interface** is a collection of useful functions.
- **The IIC interface** is an implementation on the Python core of the IIC bus Master. It allows Python to create one or more IIC bus on the available GPIO pins.
- **The SPI interface** is an implementation on the Python core of the SPI bus Master. It allows Python to create one or more SPI bus on the available GPIO pins.
- **The GPS interface** is the interface between Python and mobile internal GPS controller. It is used in order to handle GPS controller without dedicated AT commands through MDM built-in module.

For the debug, the print command is directly forwarded on the EMMI TX pin (second serial port) at baud rate 115200bps 8N1.



5.5.4. Python core supported features

The Python core version is 1.5.2+ (string methods added to 1.5.2).
You can use all Python statements and almost all Python built-in types and functions.

Built-in types and functions not supported	Available modules (all others are not supported)
complex	marshal
float	imp
long	<code>_main_</code>
docstring	<code>_builtin_</code>
	sys
	md5



5.5.5. Python Build-in Custom Modules

Several build in custom modules have been included in the python core, specifically aimed at the hardware environment of the module.

The build in modules included are:

<i>MDM</i>	interface between Python and mobile internal AT command handling
<i>MDM2</i>	second interface between Python and mobile internal AT command handling
<i>SER</i>	interface between Python and mobile internal serial port ASC0 direct handling
<i>SER2</i>	interface between Python and mobile internal serial port ASC1 direct handling
<i>GPIO</i>	interface between Python and mobile internal general purpose input output direct handling
<i>MOD</i>	interface between Python and mobile miscellaneous functions
<i>IIC</i>	custom software Inter IC bus that can be mapped on creation over almost any GPIO pin available
<i>SPI</i>	custom software Serial Protocol Interface bus that can be mapped on creation over almost any GPIO pin available
<i>GPS</i>	interface between Python and mobile internal GPS controller



NOTE: More details about the Python modules are available in the Python Easy Script document.



5.6. SAP: SIM Access Profile

5.6.1. Product architecture

The SAP feature allow the module to use the SIM of a remote SIM Server. This feature is implemented using special AT Command on a Virtual circuit of the CMUX interface.

5.6.2. Implementation feature

- SAP is based on 7.10 CMUX Basic Option used
- Only SAP Client features
- Logic HW flow control is recommended on the Virtual instance selected for the SAP command.

5.6.3. Remote SIM Message Command Description

The module sends request commands to the client application through a binary message that is crowned in the CMUX message. The client application shall extract the message and send it to the SAP server, through the appropriate protocols (e.g. by RFCOMM, that is the Bluetooth serial port emulation entity).

The client application shall extract all the messages sent by SAP server and put them in the CMUX message, to sent to the module.

The module satisfies the following feature requirements:

- Connection management
- Transfer APDU
- Transfer ATR
- Power SIM on
- Report Status
- Error Handling



Every feature needs some procedures support:

Feature	Procedure
Connection Management	Connect
	Report Status
	Transfer ATR
	Disconnection Initiated by the Client
	Disconnection Initiated by the Server
Transfer APDU	Transfer APDU
Transfer ATR	Transfer ATR
Power SIM on	Power SIM on
	Transfer ATR
Report Status	Report Status
Error Handling	Error Response

Report Status, Disconnection Initiated by the Server and Error Response are independent messages sent by server. The other procedures consist of couples of messages, started by client.



NOTE:

More details about the SAP are available in the SAP User Guide.

5.7. PFM (Premium FOTA Management)

Premium FOTA Management (PFM) provides a cost-effective, fast, secure and reliable way for wirelessly reflashing the firmware on mobile devices, ensuring that embedded software is up-to-date with the latest enhancements and features.

Customers, who want to benefit from this service, must pass through the Telit certification program, where Telit will assist the customer in validating the correct implementation of FOTA.



5.7.1. FOTA (Firmware Over The Air)

Telit, which has signed a partnership agreement with the worldwide leader of Firmware OTA technology Red Bend, has integrated its unique vCurrent® Mobile client software for use in its m2m product portfolio. Telit is therefore able to upgrade its products by transmitting only a delta file, which represents the difference between one firmware version and another.

All Telit modules, starting from SW version 7.03.x00, support Over-the-Air firmware update. Note that this service will be enabled only after signing specific agreement with Telit.

See Infinita Services > FOTA for details in www.telit.com .



6. AT Commands

The **GM862** module can be driven via the serial interface using the standard AT commands³. The **GM862** module are compliant with:

1. Hayes standard AT command set, in order to maintain the compatibility with existing SW programs.
2. ETSI GSM 07.07 specific AT command and GPRS specific commands.
3. ETSI GSM 07.05 specific AT commands for SMS (Short Message Service) and CBS (Cell Broadcast Service)
4. FAX Class 1 compatible commands

Moreover the **GM862** supports also Telit proprietary AT commands for special purposes.

For a detailed description of GM862 modules AT Commands refer to document AT Commands Reference Guide, code 80000ST10025a.

³ The AT is an ATTENTION command and is used as a prefix to other parameters in a string. The AT command combined with other parameters can be set up in the communications package or typed in manually as a command line instruction.



7. Conformity Assessments

The **Telit GM862 modules** are assessed to be conform to the R&TTE Directive as stand-alone products, so if the module is installed **in conformance with Telit Communications installation instructions** require no further evaluation under Article 3.2 of the R&TTE Directive and do not require further involvement of a R&TTE Directive Notified Body for the final product. In all other cases, or if the manufacturer of the final product is in doubt then the equipment integrating the radio module must be assessed against Article 3.2 of the R&TTE Directive. In all cases assessment of the final product must be made against the Essential requirements of the R&TTE Directive Articles 3.1(a) and (b), safety and EMC respectively, and any relevant Article 3.3 requirements. The **Telit GM862 modules** are conform with the following European Union Directives:



- R&TTE Directive 1999/5/EC (Radio Equipment & Telecommunications Terminal Equipments)
- Low Voltage Directive 73/23/EEC and product safety
- Directive 89/336/EEC for conformity for EMC

In order to satisfy the essential requisite of the R&TTE 99/5/EC directive, the GM862PCS module is compliant with the following standards:

- GSM (Radio Spectrum). Standard: EN 301 511 and 3GPP 51.010-1
- EMC (Electromagnetic Compatibility). Standards: EN 301 489-1 and EN 301 489-7
- LVD (Low Voltage Directive) Standards: EN 60 950

In this document and the Hardware User Guide, Software User Guide all the information you may need for developing a product meeting the R&TTE Directive is included.

Furthermore the **Telit GM862-QUAD, GM862-QUAD-PY and GM862-GPS modules** is FCC Approved as module to be installed in other devices. If the final product after integration is intended for portable use, a new application and FCC is required.

The **Telit GM862-QUAD, GM862-QUAD-PY and GM862-GPS modules** are conform with the following US Directives:

- Use of RF Spectrum. Standards: FCC 47 Part 24 (GSM 1900)
- EMC (Electromagnetic Compatibility). Standards: FCC47 Part 15



GM862 Product Description
80272ST10019a Rev. 12 – 2010-10-20

To meet the FCC's RF exposure rules and regulations:

- The system antenna(s) used for this transmitter must be installed to provide a separation distance of at least 20 cm from all the persons and must not be co-located or operating in conjunction with any other antenna or transmitter.
- The system antenna(s) used for this module must not exceed 3 dBi for mobile and fixed or mobile operating configurations.
- Users and installers must be provided with antenna installation instructions and transmitter operating conditions for satisfying RF exposure compliance.
- Manufacturers of mobile, fixed or portable devices incorporating this module are advised to clarify any regulatory questions and to have their complete product tested and approved for FCC compliance.

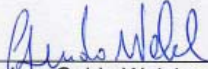

7.1. GM862-QUAD: Conformity Assessment

	DECLARATION OF CONFORMITY
We,	<i>Telit Communications S.p.A</i>
Of:	<i>Via Stazione di Prosecco, 5/b 34010 Sgonico (TRIESTE) ITALY</i>
declare under our sole responsibility that the product	
GM862-QUAD	
to which this declaration relates is in conformity with all the essential requirements of Directive 1999/05/EC, Articles 3.1(a), 3.1(b) & 3.2).	
The conformity with the essential requirements of the European Directive 1999/05/EC has been verified against the following harmonized standards:	
<ul style="list-style-type: none">• ETSI EN 301 511 v.9.0.2;• CENELEC EN 60950:2001;• ETSI EN 301 489-1: v.1.5.1;• ETSI EN 301 489-7: v.1.2.1.	
The conformity assessment procedure referred to in Article 10 and detailed in Annex IV of Directive 1999/5/EC has been followed with the involvement of the following Notified Body:	
BABT, Balfour House, Churchfield Road, Walton-on-Thames, Surrey, KT12 2TD, United Kingdom	
Identification mark:	0168
Certificate number:	NC/13026 Issue date: 05 December 2006
The technical documentation relevant to the above equipment will be held at:	
<i>Telit Communications S.p.A Via Stazione di Prosecco, 5/b 34010 Sgonico (TRIESTE) ITALY</i>	
Trieste, 11 December 2006	 Ing. Guido Walcher Quality Assurance Director



ZERTIFIKAT • CERTIFICATE • 認証証書 • CERTIFICADO • CERTIFICAT



Certificate

This certificate is issued to

TELIT Communications S.p.A.

of

Via Stazione di Prosecco 5/B
34010 Sgonico
Trieste
Italy

to certify that the Equipment known as

GM862-QUAD

as described in the Annex to this certificate conforms to the essential requirements of Directive 1999/5/EC of the European Parliament and European Council on the basis of Technical Construction File number 24759_GM862-QUAD_rev1 in relation to the essential requirements of Articles 3.1(a), 3.1(b) & 3.2 of the Directive.

Signed:

On Behalf of B A B T

Issue Date: 05 December 2006

Number: NC/13026 Issue: 01

This certificate is issued by B A B T and represents a formal Notified Body opinion under Annex IV of Directive 1999/5/EC permitting the use of the B A B T (CE)168 mark on the equipment described above subject to the equipment meeting the compliance requirements of all applicable EU directives. This certificate is not transferable and remains the property of B A B T.

British Approvals Board for Telecommunications • TÜV SÜD Group •
Balfour House • Churchfield Road • Walton-on-Thames • Surrey • KT12 2TD • United Kingdom



7.2. GM862-QUAD-PY: Conformity Assessment

 **DECLARATION OF CONFORMITY**

We, **Telit Communications S.p.A**

Of: **Via Stazione di Prosecco, 5/b
34010 Sgonico (TRIESTE)
ITALY**

declare under our sole responsibility that the product

GM862-QUAD-PY

to which this declaration relates is in conformity with all the essential requirements of Directive 1999/05/EC, Articles 3.1(a), 3.1(b) & 3.2).

The conformity with the essential requirements of the European Directive 1999/05/EC has been verified against the following harmonized standards:

- ETSI EN 301 511 v.9.0.2;
- CENELEC EN 60950:2001;
- ETSI EN 301 489-1: v.1.5.1;
- ETSI EN 301 489-7: v.1.2.1.

The conformity assessment procedure referred to in Article 10 and detailed in Annex IV of Directive 1999/5/EC has been followed with the involvement of the following Notified Body:

**BABT, Balfour House, Churchfield Road, Walton-on-Thames, Surrey, KT12
2TD, United Kingdom**

Identification mark: **0168**

Certificate number: NC/13025 Issue date: 05 December 2006

The technical documentation relevant to the above equipment will be held at:

**Telit Communications S.p.A
Via Stazione di Prosecco, 5/b
34010 Sgonico (TRIESTE)
ITALY**

Trieste, **11 December 2006**

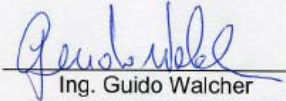
 Ing. Guido Walcher
 Quality Assurance Director



ZERTIFIKAT • CERTIFICATE • 認証証書 • CERTIFICADO • CERTIFICAT



Certificate

This certificate is issued to

TELIT Communications S.p.A.

of

Via Stazione di Prosecco 5/B
34010 Sgonico
Trieste
Italy

to certify that the Equipment known as

GM862-QUAD-PY

as described in the Annex to this certificate conforms to the essential requirements of Directive 1999/5/EC of the European Parliament and European Council on the basis of Technical Construction File number 24750_GM862-QUAD-PY_rev1 in relation to the essential requirements of Articles 3.1(a), 3.1(b) & 3.2 of the Directive.

Signed:

On Behalf of BABT

Issue Date: 05 December 2006

Number: NC/13025 Issue: 01

This certificate is issued by BABT and represents a formal Notified Body opinion under Annex IV of Directive 1999/5/EC permitting the use of the BABT CE0168 mark on the equipment described above subject to the equipment meeting the compliance requirements of all applicable EU directives. This certificate is not transferable and remains the property of BABT.

British Approvals Board for Telecommunications • TÜV SÜD Group •
Balfour House • Churchfield Road • Walton-on-Thames • Surrey • KT12 2TD • United Kingdom



7.3. GM862-QUAD/QUAD-PY/GPS: RoHS certificate

DECLARATION OF EU RoHS Compliance

We, *Telit Communications S.p.A*

Of: *Via Stazione di Prosecco, 5/b
34010 Sgonico (TRIESTE)
ITALY*

declare under our sole responsibility that the products:

GM862-GPS
GM862-QUAD-PY
GM862-QUAD

to which this declaration relates, is in full compliance with EU Directive 2002/95/EC on restriction of the use of certain Hazardous Substances in electrical and electronic equipment (RoHS), subsequent amendments and the European Court of Justice decision on Deca-BDE substances from July 1, 2008.

The technical documentation or other information showing that electrical and electronic equipment which has put on the market, complies the requirements of regulation, will be held at:

*Telit Communications S.p.A
Via Stazione di Prosecco, 5/b
34010 Sgonico (TRIESTE)
ITALY*

Trieste, **30 July 2008**

Antonino Sgroi
R&D Head

Guido Walcher
Quality Director

Rev.2



7.4. GM862-QUAD / QUAD-PY: FCC Equipment Authorization

TCB

**GRANT OF EQUIPMENT
AUTHORIZATION**

TCB

Certification
Issued Under the Authority of the
Federal Communications Commission
By:

MET Laboratories, Inc.
914 W. Patapsco Avenue
Baltimore, MD 21230-3432

Date of Grant: 11/29/2006
Application Dated: 11/29/2006

Telit Communications S.p.A.
Viale Stazione di Prosecco 5/b
Trieste, 34010
Italy

Attention: Andrea Fragiaco, Ing.

NOT TRANSFERABLE

EQUIPMENT AUTHORIZATION is hereby issued to the named GRANTEE, and is VALID ONLY for the equipment identified hereon for use under the Commission's Rules and Regulations listed below.

FCC IDENTIFIER: **RI7GM862L**
Name of Grantee: **Telit Communications S.p.A.**
Equipment Class: **PCS Licensed Transmitter**
Notes: **Quad-Band GSM/GPRS module**

<u>Grant Notes</u>	<u>FCC Rule Parts</u>	<u>Frequency Range (MHZ)</u>	<u>Output Watts</u>	<u>Frequency Tolerance</u>	<u>Emission Designator</u>
	22H	824.2 - 848.8	1.48	1.0 PM	290KGXW
	24E	1850.2 - 1909.8	0.25	1.0 PM	290KGXW

Power Output is ERP for Part 22 and EIRP for Part 24. The antenna(s) used for this transmitter must be installed to provide a separation distance of at least 20 cm from all persons and must not be co-located or operating in conjunction with any other antenna or transmitter. Installers and end-users must be provided with installation instructions and transmitter operating conditions for satisfying RF exposure compliance.

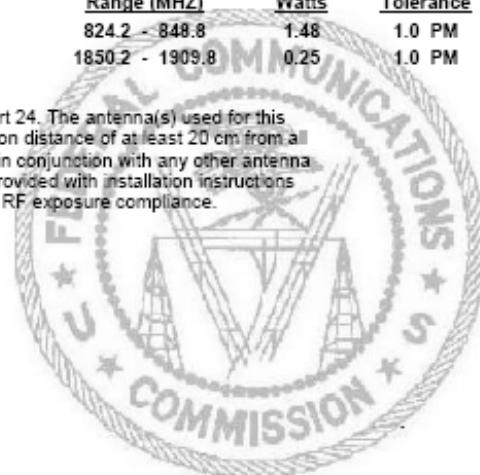

7.5. GM862-QUAD / QUAD-PY: IC Equipment Authorization



GRANT OF EQUIPMENT CERTIFICATION

THE FOLLOWING EQUIPMENT HAS BEEN TESTED
AND CERTIFIED UNDER
INDUSTRY CANADA
RSS 132 ISSUE 1 PROVISIONAL AUG 2002, RSS 133 ISSUE 3 JUNE 2005

CB

Issued By:
MET Laboratories, Inc.
914 W. Patapsco Avenue
Baltimore, Maryland 21230
Laboratory Number: 2043

CB

Equipment Certification is hereby issued to the Identified Certificate Holder and is VALID ONLY for the equipment identified herein.
La certification d'équipement est par ceci publiée au support identifié de certificate et est VALIDE SEULEMENT pour l'équipement identifié ci-dessus.
NOT TRANSFERABLE / NON TRANSMISSIBLE

FILE/CERTIFICATE NUMBER: 099-11-2006-21243

CERTIFICATION NUMBER: IC: 5131A-GM862L

Issued to/Délicivré a: Telit Communications S.p.A.
Address: Viale Stazione di Prosecco 5/B
I-34010 Trieste, Italy

Date of Grant: November 28, 2006

Nature of Application/Nature d'Application: Original
Equipment Description/Genre de Matériel: Quad-Band GSM/GPRS module
Equipment Category/Catégorie de Matériel: Category I

Model Number(s)/Marque et Modèle: GM862-QUAD and GM862-QUAD-PY
Conducted RF Power or Field Strength/Puissance H.F.: 1.48 Watts and 0.25 Watts
Frequency Range/Bande de Fréquences: 824.2-848.8MHz and 1850.2-1909.8 MHz
Bandwidth(s)/ largeurs de bande: 290 KHz
Emission Designations/Genre D'Émission : 290KGXW
Antenna Information/ l'information d'antenne: NA

Test Lab: Cetecom S.A. Parque Tecnológico de Andaluci, C/Severo Ochoa 2, 29590 Campanillas, Malaga, Spain
rorej@s@cetecom.es Tel: 34-952-61-93-57
Test Lab IC Site Number: IC-4621

Notes: Power Output is ERP for Part 22 and EIRP for Part 24. The antenna(s) used for this transmitter must be installed to provide a separation distance of at least 20 cm from all persons and must not be co-located or operating in conjunction with any other antenna or transmitter. Installers and end-users must be provided with installation instructions and transmitter operating conditions for satisfying RF exposure compliance.

Certification of equipment means only that the equipment met the requirements of the above noted specification(s). License applications, where applicable to use certified equipment, are acted on accordingly by the issuing office and will depend on the existing radio environment, service and location of operation. This certificate is issued on condition that the holder complies and will continue to comply with requirements and procedures issued by Industry Canada.

L'homologation de matériel terminal signifie seulement qu'il est conforme aux exigences du cahier des charges mentionnés ci-dessus. Les demandes de licence, le cas échéant en vue de l'utilisation de matériel certifié seront traitées en conséquence par le bureau chargé de délivrer les dites licences, en tenant compte du milieu radioélectrique ambiant, du service radio existant et de l'emplacement de la station. Le présent certificat est délivré à condition que le détenteur se conforme et continue à se conformer aux cahiers des charges et procédures sur les normes radioélectriques publiées par le ministère.

ISSUED UNDER THE AUTHORITY OF THE MINISTER OF INDUSTRY
DELIVRE AVEC L'AUTORISATION DU MINISTRE DES INDUSTRIES

Kevin McAuliffe
Manager, EMC Laboratory, MET Laboratories
Printed: November 28, 2006



DOC-ICR001 3/11/2005

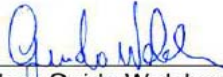

7.6. GM862-GPS: Conformity Assessment

	DECLARATION OF CONFORMITY
We, Telit Communications S.p.A	
Of: Via Stazione di Prosecco, 5/b 34010 Sgonico (TRIESTE) ITALY	
declare under our sole responsibility that the product GM862-GPS	
to which this declaration relates is in conformity with all the essential requirements of Directive 1999/05/EC	
The conformity with the essential requirements of the European Directive 1999/05/EC has been verified against the following harmonized standards:	
<ul style="list-style-type: none">• ETSI EN 301 511 v.9.0.2;• CENELEC EN 60950:2001;• ETSI EN 301 489-1: v.1.4.1;• ETSI EN 301 489-7: v.1.2.1.	
The conformity assessment procedure referred to in Article 10 and detailed in Annex IV of Directive 1999/5/EC has been followed with the involvement of the following Notified Body:	
BABT, Balfour House, Churchfield Road, Walton-on-Thames, Surrey, KT12 2TD, United Kingdom	
Identification mark:	0168
The technical documentation relevant to the above equipment will be held at:	
Telit Communications S.p.A Via Stazione di Prosecco, 5/b 34010 Sgonico (TRIESTE) ITALY	
Trieste, 04 August 2006	 Ing. Guido Walcher Quality Assurance Director
06DOC12 MOD.003 02/06 REV.9	



ZERTIFIKAT • CERTIFICATE • 認証証書 • CERTIFICADO • CERTIFICAT



Certificate

This certificate is issued to

TELIT Communications S.p.A.

of

Via Stazione di Prosecco 5/B
34010 Sgonico
Trieste
Italy

to certify that the Equipment known as

GM862-GPS

as described in the Annex to this certificate conforms to the essential requirements of Directive 1999/5/EC of the European Parliament and European Council on the basis of Technical Construction File number 24435_GM862-GPS_rev1 in relation to the essential requirements of Articles 3.1(a), 3.1(b) & 3.2 of the Directive.

Signed:

On Behalf of BABT

Issue Date: 03 August 2006

Number: NC/12874 Issue: 01

This certificate is issued by BABT and represents a formal Notified Body opinion under Annex IV of Directive 1999/5/EC permitting the use of the BABT (€)168 mark on the equipment described above subject to the equipment meeting the compliance requirements of all applicable EU directives. This certificate is not transferable and remains the property of BABT.

British Approvals Board for Telecommunications • TÜV SÜD Group •
Ballour House • Churchfield Road • Walton-on-Thames • Surrey • KT12 2TD • United Kingdom



7.7. GM862-GPS FCC Equipment Authorization

TCB

**GRANT OF EQUIPMENT
AUTHORIZATION**

TCB

Certification
Issued Under the Authority of the
Federal Communications Commission
By:

MET Laboratories, Inc.
914 W. Patapsco Avenue
Baltimore, MD 21230-3432

Date of Grant: 07/28/2006
Application Dated: 07/28/2006

Telit Communications S.p.A.
Viale Stazione di Prosecco 5/b
Trieste, 34010
Italy

Attention: Andrea Fragiacomano, Ing.

NOT TRANSFERABLE

EQUIPMENT AUTHORIZATION is hereby issued to the named GRANTEE, and is VALID ONLY for the equipment identified hereon for use under the Commission's Rules and Regulations listed below.

FCC IDENTIFIER: RI7GM862G
Name of Grantee: Telit Communications S.p.A.
Equipment Class: PCS Licensed Transmitter
Notes: Quad-Band GSM/GPRS module - Type: GM862-GPS

<u>Grant Notes</u>	<u>FCC Rule Parts</u>	<u>Frequency Range (MHZ)</u>	<u>Output Watts</u>	<u>Frequency Tolerance</u>	<u>Emission Designator</u>
	22H	824.2 - 848.8	1.48	1.0 PM	290KGXW
	24E	1850.2 - 1909.8	0.25	1.0 PM	290KGXW

Power Output is ERP for Part 22 and EIRP for Part 24. The antenna(s) used for this transmitter must be installed to provide a separation distance of at least 20 cm from all persons and must not be co-located or operating in conjunction with any other antenna or transmitter. Installers and end-users must be provided with installation instructions and transmitter operating conditions for satisfying RF exposure compliance.

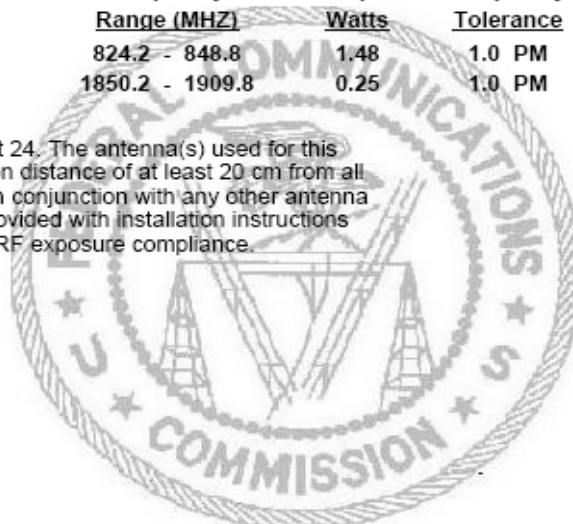

7.8. GM862-GPS IC Equipment Authorization



GRANT OF EQUIPMENT CERTIFICATION

THE FOLLOWING EQUIPMENT HAS BEEN TESTED
AND CERTIFIED UNDER
INDUSTRY CANADA

RSS 132 ISSUE 1 PROVISIONAL AUG. 2002, RSS 133 ISSUE 3, JUNE 2005

CB

Issued By:

CB

MET Laboratories, Inc.
914 W. Patapsco Avenue
Baltimore, Maryland 21230
Laboratory Number: 2043

Equipment Certification is hereby issued to the Identified Certificate Holder and is VALID ONLY for the equipment identified herein.
La certification d'équipement est par ceci publiée au support identifié de certificate et est VALIDE SEULEMENT pour l'équipement identifié ci-dessus
NOT TRANSFERABLE / NON TRANSMISSIBLE

FILE/CERTIFICATE NUMBER: 080-07-2006-20415

CERTIFICATION NUMBER: IC: 5131A-GM862G

Issued to/Délivré a: Telit Communications S.p.A. Date of Grant: July 28, 2006
Address: Viale Stazione di Prosecco 5/B
I-34010 Trieste, Italy

Nature of Application/Nature d'Application:	Original
Equipment Description/Genre de Matériel:	Quad-Band GSM/GPRS module
Equipment Category/Catégorie de Matériel:	Category I
Model Number(s)/Marque et Modèle	GM862-GPS
Conducted RF Power or Field Strength/Puissance H.F.:	1.48 Watts(eirp) and 0.25 Watts(erp)
Frequency Range/Bande de Fréquences:	824.2-848.8MHz and 1850.2-1909.8 MHz
Bandwidth(s)/ largeurs de bande:	290 KHz
Emission Designations/Genre D'Émission:	290KGXW
Antenna Information/ l'information d'antenne:	N/A

Test Lab: rorejas@cetecom.es Tel: 34-952-61-93-57

Test Lab IC Site Number: IC-4621

Notes: Power Output is ERP for Part 22 and EIRP for Part 24. The antenna(s) used for this transmitter must be installed to provide a separation distance of at least 20 cm from all persons and must not be co-located or operating in conjunction with any other antenna or transmitter. Installers and end-users must be provided with installation instructions and transmitter operating conditions for satisfying RF exposure compliance.

Certification of equipment means only that the equipment met the requirements of the above noted specification(s). License applications, where applicable to use certified equipment, are acted on accordingly by the issuing office and will depend on the existing radio environment, service and location of operation. This certificate is issued on condition that the holder complies and will continue to comply with requirements and procedures issued by Industry Canada.

L'homologation de matériel terminal signifie seulement qu'il est conforme aux exigences du cahier des charges mentionné ci-dessus. Les demandes de licence, le cas échéant en vue de l'utilisation de matériel certifié seront traitées en conséquence par le bureau chargé de délivrer les dites licences, en tenant compte du milieu radioélectrique ambiant, du service radio existant et de l'emplacement de la station. Le présent certificate est délivré à condition que le détenteur se conforme et continue à se conformer aux cahiers des charges et procédures sur les norms radioélectriques publiées par le ministère.

ISSUED UNDER THE AUTHORITY OF THE MINISTER OF INDUSTRY
DELIVRE AVEC L'AUTORISATION DU MINISTRE DES INDUSTRIES



Kevin Mahaffey
Manager, EMC Laboratory
Printed: July 28, 2006



DOC-ICR001 3/11/2005



8. SAFETY RECOMMENDATIONS



NOTE:

Read this section carefully to ensure the safe operation.

Be sure the use of this product is allowed in the country and in the environment required. The use of this product may be dangerous and has to be avoided in the following areas:

- Where it can interfere with other electronic devices in environments such as hospitals, airports, aircrafts, etc
- Where there is risk of explosion such as gasoline stations, oil refineries, etc

It is responsibility of the user to enforce the country regulation and the specific environment regulation.

Do not disassemble the product; any mark of tampering will compromise the warranty validity. We recommend following the instructions of the hardware user guides for a correct wiring of the product. The product has to be supplied with a stabilized voltage source and the wiring has to be conforming to the security and fire prevention regulations.

The product has to be handled with care, avoiding any contact with the pins because electrostatic discharges may damage the product itself. Same cautions have to be taken for the SIM, checking carefully the instruction for its use. Do not insert or remove the SIM when the product is in power saving mode.

The system integrator is responsible of the functioning of the final product; therefore, care has to be taken to the external components of the module, as well as of any project or installation issue, because the risk of disturbing the GSM network or external devices or having impact on the security. Should there be any doubt, please refer to the technical documentation and the regulations in force.

Every module has to be equipped with a proper antenna with specific characteristics. The antenna has to be installed with care in order to avoid any interference with other electronic devices and has to guarantee a minimum distance from the body (20 cm). In case of this requirement cannot be satisfied, the system integrator has to assess the final product against the SAR regulation EN 50360.

The European Community provides some Directives for the electronic equipments introduced on the market. All the relevant information's are available on the European Community website:

<http://ec.europa.eu/enterprise/sectors/rtte/documents/>

The text of the Directive 99/05 regarding telecommunication equipments is available, while the applicable Directives (Low Voltage and EMC) are available at:

<http://ec.europa.eu/enterprise/sectors/electrical/>



9. Acronyms

Abbreviation	Description
ACM	Accumulated Call Meter
ASCII	American Standard Code for Information Interchange
AT	Attention commands
BGA	Ball Grid Array (of solder balls on surface mount devices)
CB	Cell Broadcast
CBS	Cell Broadcasting Service
CCM	Call Control Meter
CLIP	Calling Line Identification Presentation
CLIR	Calling Line Identification Restriction
CMOS	Complementary Metal-Oxide Semiconductor
CR	Carriage Return
CSD	Circuit Switched Data
CTS	Clear To Send
DAI	Digital Audio Interface
DCD	Data Carrier Detected
DCE	Data Communications Equipment
DRX	Data Receive
DSR	Data Set Ready
DTA	Data Terminal Adaptor
DTE	Data Terminal Equipment
DTMF	Dual Tone Multi Frequency
DTR	Data Terminal Ready
EMC	Electromagnetic Compatibility
ETSI	European Telecommunications Equipment Institute
FTA	Full Type Approval (ETSI)
FTP	File Transfer Protocol
GGA	Global Positioning System Fix Data
GLL	Geographic Posotion – Latitude/Longitude
GPS	Global Positioning System, based on reception of signals from orbiting satellites
GPRS	General Radio Packet Service
GSA	GPS receiver operating mode, SVs used for navigation, and DOP values.
GSM	Global System for Mobile communication
GSV	Number of SVs in view, PRN numbers, elevation, azimuth & SNR values.
HF	Hands Free
IMEI	International Mobile Equipment Identity
IMSI	International Mobile Subscriber Identity
IRA	International Reference Alphabet



GM862 Product Description
80272ST10019a Rev. 12 – 2010-10-20

ITU	International Telecommunications Union
IWF	Inter-Working Function
LCD	Liquid Crystal Display
LED	Light Emitting Diode
LF	Linefeed
ME	Mobile Equipment
MMI	Man Machine Interface
MO	Mobile Originated
MS	Mobile Station
MT	Mobile Terminated
NMEA	National Marine Electronics Association
OEM	Other Equipment Manufacturer
PB	Phone Book
PDU	Protocol Data Unit
PH	Packet Handler
PIN	Personal Identity Number
PLMN	Public Land Mobile Network
PPS	Precision Positioning Service
PUCT	Price per Unit Currency Table
PUK	PIN Unblocking Code
RACH	Random Access Channel
RLP	Radio Link Protocol
RMC	Recommended Minimum Specific GPS/TRANSIT Data
RMS	Root Mean Square
RoHS	Reduction of Hazardous Substances
RTS	Ready To Send
RI	Ring Indicator
SCA	Service Center Address
SIM	Subscriber Identity Module
SMD	Surface Mounted Device
SMS	Short Message Service
SMSC	Short Message Service Center
SPS	Standard Positioning Service
SS	Supplementary Service
TIA	Telecommunications Industry Association
TTFF	Time To First Fix
UDUB	User Determined User Busy
USSD	Unstructured Supplementary Service Data
VTG	Actual track made good and speed over ground

