



IP EASY USER GUIDE

Technical Specification

80000ST10028A Rev. 26 – 2021-07-22

APPLICABILITY TABLE

PRODUCTS	Platform Version ID	Technology	
GL865 SERIES	10	2G	
GE865-QUAD			
GE864 V2 SERIES			
GL868-DUAL			
GE910 SERIES	13		
GE910-QUAD-V3	16		
GE866-QUAD			
GL865 V3 SERIES			
GL868-DUAL V3			
HE910 SERIES	12		3G
UE910 SERIES			
UL865 SERIES			
UE866 SERIES			
LE910 Cat1 SERIES	20	4G	
LE910 V2 SERIES			
LE866 SERIES	23		
ME866A1 SERIES			
LE910Cx SERIES	25		
ME910C1 SERIES	30		
ML865C1 SERIES			
ME310G1 SERIES	37		
ME910G1 SERIES			
ML865G1 SERIES			



Platform Version ID is a reference used in the document to identify a series of modules; each module is named with the serial name followed by a suffix (series name-suffix). In addition, Platform Version ID is used in the tag of the different SW versions, e.g. 10 for SW version 10.xx.xxx, 13 for SW version 13.xx.xxx, etc..

CONTENTS

APPLICABILITY TABLE	2
CONTENTS	3
FIGURES LIST	12
TABLES LIST	13
AT COMMANDS LIST	14
1. INTRODUCTION	15
1.1. Scope	15
1.2. Audience	15
1.3. Contact Information, Support	15
1.4. Symbol Convention	16
1.5. Related Documents	17
2. PRELIMINARY INFORMATION	18
3. IP EASY FEATURES	19
4. 2G/3G MODULES	22
4.1. Context Types	22
4.1.1. PDP Context Setting, +CGDCONT Command	22
4.1.2. Example 2G	22
4.1.3. Example 3G	23
4.2. PDP Context Activation, #SGACT Command	23
4.2.1. Max Number of Active PDP Contexts	25
4.2.2. Automatic Activation/Reactivation, #SGACTCFG Command	28
4.2.3. Abort Context Activation, #SGACTCFGEXT Command	28
4.2.4. Authentication Setting, #SGACTAUTH Command	28
4.2.5. Examples	29
4.2.5.1. PDP Contexts and Sockets Bindings	29
4.2.5.2. PDP Context Activation/Reactivation	31
4.3. PDP Context Activation, +CGACT Command	31
4.4. IP Address Information, #CGPADDR Command	32
4.5. QoS Setting (2G/3G)	34



4.5.1.	Minimum QoS Setting, +CGQMIN Command	34
4.5.1.1.	Examples 2G	34
4.5.2.	Required QoS Setting, +CGQREQ Command	36
4.6.	QoS Setting (3G)	37
4.6.1.	Minimum QoS Setting, +CGEQMIN Command	37
4.6.2.	Required QoS Setting, +CGEQREQ Command	38
5.	4G MODULES	39
5.1.	Default EPS Bearer at Power ON	39
5.2.	PDP Context Setting, +CGDCONT Command	41
5.2.1.	Platform Version ID 20	41
5.2.1.1.	Modules: LE910 Series	42
5.2.1.2.	Modules: LE910-SV1, -SVL, SV V2	42
5.2.2.	Platform Version ID 23	43
5.2.2.1.	Modules: LE866-SV1, ME866A1-NV	44
5.2.2.2.	Modules: LE866A1-NA, -KK, -JS, -KS, ME866A1-NA	45
5.2.3.	Platform Version ID 25	46
5.2.3.1.	Modules: LE910Cx Series	46
5.2.4.	Platform Version ID 30, 37	46
5.3.	Establish a Default EPS Bearer	47
5.4.	PDP Context Activation, #SGACT Command	47
5.4.1.	Max Number of Active PDP Contexts	48
5.4.2.	Platform Version ID 20	48
5.4.2.1.	Modules: LE910 Series	49
5.4.2.2.	Modules: LE910-SV1, -SVL, SV V2	49
5.4.3.	Platform Version ID 23, 25	49
5.4.3.1.	Platform Version ID 23	49
5.4.3.2.	Platform Version ID 23, 25	50
5.4.4.	Platform Version ID 30, 37	50
5.5.	IP Address Information, #CGPADDR Command	50
5.6.	Change a Default EPS Bearer	51
5.7.	Dedicated EPS Bearer	53
5.8.	Multiple PDN, #DUALAPN Command	54

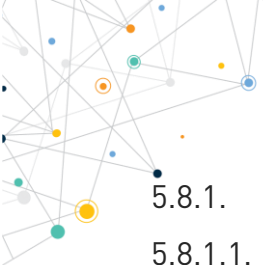

5.8.1.	Platform Version ID 20	54
5.8.1.1.	Modules: LE910 Series	54
5.8.1.2.	Examples on #DUALAPN=0 Mode	55
5.8.1.3.	Examples on #DUALAPN=1 Mode	58
5.8.2.	Platform Version ID 30, 37	62
5.8.2.1.	Platform Version ID 30, 37 - Example	62
5.9.	Authentication Setting, #PDPAUTH Command	63
5.9.1.	Platform Version ID 20 and 25	63
5.9.1.1.	Modules: LE910 and, LE910Cx Series	63
5.9.2.	Platform Version ID 30, 37	64
5.9.2.1.	Platform Version ID 30, 37 - Example	65
6.	OUTGOING SOCKETS IN ONLINE MODE	66
6.1.	Sockets Configuration, #SCFG Command	66
6.1.1.	2G/3G Modules	66
6.1.2.	4G Modules	67
6.1.2.1.	Platform Version ID 20	67
6.1.2.2.	Platform Version ID 23	70
6.1.2.3.	Platform Version ID 30, 37	71
6.2.	Open a Socket, #SD Command	72
6.2.1.	Example on Opening & Suspension, (2G/3G)	73
6.3.	Pending Data, #PADCMD, #PADFWD Commands	74
6.4.	Resume a Connection, #SO Command	75
6.5.	Close a Connection, #SH, #SLASTCLOSURE Commands	76
6.6.	TCP/IP Options Configuration	77
6.6.1.	Reassemble TCP Packets, #TCPREASS Command (2G)	77
6.6.2.	Max TCP Payload Size, #TCPMAXDAT Command (2G)	77
6.6.3.	#BASE64 Command	78
7.	INCOMING SOCKETS IN ONLINE MODE	80
7.1.	Accept an Incoming Connection, #SA Command	81
7.2.	Check the Socket State, #SS Command	82
7.3.	Open UDP Connection, #SLUDP Command	82
7.4.	Firewall Setting, #FRWL Command	83

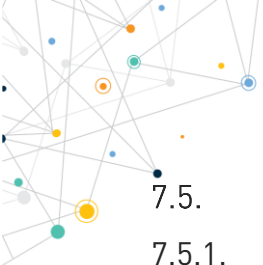

7.5.	Examples	84
7.5.1.	Modules in Server and Client Configurations	84
8.	SOCKET CONNECTION IN COMMAND MODE	87
8.1.	Open a Socket, #SD Command	87
8.2.	Accept an Incoming Connection, #SA Command	87
8.3.	Extended Socket Parameters Configuration	88
8.3.1.	#SCFGEXT Command	88
8.3.2.	#SCFGEXT2 Command	89
8.3.2.1.	2G modules	89
8.3.2.2.	3G/4G modules	89
8.4.	Send Data, #SEND and #SENDEXT Commands	90
8.5.	Receive Data, #SRECV Command	90
8.6.	Socket Information, #SI Command	91
8.7.	Examples	92
8.7.1.	Switching from COMMAND to ONLINE Mode and Back	92
8.7.2.	Accept a Socket Connection in COMMAND Mode	93
8.7.3.	SRING Unsolicited Mode: Normal	93
8.7.4.	SRING Unsolicited Mode: Data amount	94
8.7.5.	SRING Unsolicited Mode: Data view	95
8.7.6.	SRING Unsolicited Mode: Data view UDP	97
9.	MULTI-SOCKET & PROTOCOL SERVICE SOCKETS	99
9.1.	2G/3G Modules	99
9.2.	4G Modules	100
9.2.1.	#PROTOCOLCFG Command	100
9.2.2.	Platform Version ID 20	100
9.2.2.1.	Modules: LE910 Series	100
9.2.2.2.	Modules: LE910-SV1, -SVL, SV V2	102
9.2.3.	Platform Version ID 25	104
9.2.3.1.	Modules: LE910Cx	104
10.	HTTP PROTOCOL	106
10.1.	#HTTPCFG Command	106

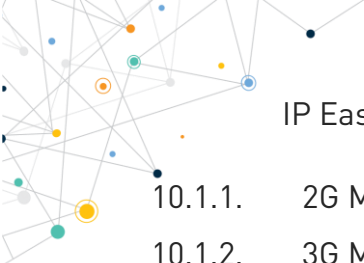

10.1.1.	2G Modules	106
10.1.2.	3G Modules	107
10.1.3.	4G Modules	109
10.1.3.1.	Platform Version ID 20	109
10.1.3.2.	Platform Version ID 23	110
10.1.3.3.	Platform Version ID 25	110
10.1.3.4.	Platform Version ID 30, 37	111
10.2.	#HTTPQRY: GET, HEAD, DELETE	111
10.3.	#HTTPSND: POST, PUT	112
10.4.	Examples	113
10.4.1.	GET Command (2G)	113
10.4.2.	POST Command (2G)	114
10.4.3.	PUT Command (2G)	115
10.4.4.	HTTP Client with #SD	115
11.	SMTP PROTOCOL	118
11.1.	2G Modules	118
11.2.	3G Modules	119
11.3.	4G Modules	120
11.3.1.	Platform Version ID 20, 23	120
11.3.2.	Platform Version ID 25	120
11.3.3.	Platform Version ID 30, 37	121
11.4.	E-mail Sending, with no Attachment	121
11.5.	E-mail Sending, with Attachment	121
11.6.	Examples	122
11.6.1.	With no Attachment	122
11.6.2.	With Attachment	123
11.6.3.	Sending with #SD	124
11.6.4.	Receiving with #SD	125
12.	FTP PROTOCOL	127
12.1.	2G/3G Modules	127
12.2.	4G Modules	128
12.3.	Examples	129

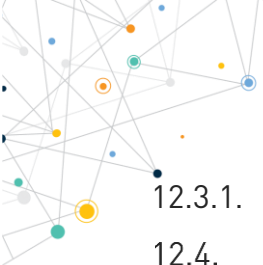

12.3.1.	Open Six Sockets and the FTP Connection	129
12.4.	FTP Time Out Setting, #FTPTO Command	131
12.5.	FTP Transfer Type Setting, #FTPTYPE Command	132
12.6.	FTP Uploading, #FTPPUT, #FTPAPPEXT Command	132
12.7.	#FTPSIZE, #FTPAPP Commands	132
12.8.	Examples	133
12.8.1.	Data Uploading in ONLINE Mode	133
12.8.2.	Data Uploading in COMMAND Mode	135
12.9.	FTP Downloading	136
12.9.1.	Downloading in ONLINE Mode	136
12.9.2.	Downloading in COMMAND Mode	136
12.10.	FTP Downloading Restart	137
12.11.	Examples	137
12.11.1.	File Downloading in ONLINE Mode	137
12.11.2.	File Downloading in COMMAND Mode	139
12.11.3.	FTP and 4G Modules	140
13.	MQTT PROTOCOL	144
13.1.	MQTT Client Initialization, #MQEN Command	144
13.2.	MQTT Client Configuration Commands	145
13.2.1.	#MQCFG Command	145
13.2.2.	#MQCFG2 Command	146
13.2.3.	#MQWCFG Command	146
13.2.4.	#MQTCFG Command	147
13.3.	MQTT Client Connection Commands	148
13.3.1.	#MQCONN Command	148
13.3.2.	#MQDISC Command	148
13.4.	Example	149
13.4.1.	MQTT Client Connection Unsecured	149
13.5.	MQTT Operations - Publish, Subscribe and Unsubscribe Commands	151
13.5.1.	#MQPUBS Command	151
13.5.2.	#MQSUB Command	151
13.5.3.	#MQUNS Command	152

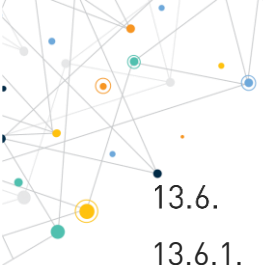

13.6.	MQTT Publish Read	152
13.6.1.	#MQRING URC	152
13.6.2.	#MQREAD Command	153
13.7.	Example	153
13.7.1.	Publish, Subscribe and Unsubscribe Operations	153
14.	PING PROTOCOL	157
14.1.	2G/3G Modules	157
14.2.	4G Modules	158
15.	EASY GSM: IP OVER CSD	160
15.1.	GSM Context Setting	160
15.2.	GSM Context Activation	161
15.3.	Examples	161
15.3.1.	GSM/PDP Contexts & FTP Protocol	161
15.3.2.	GSM Context & +COPS=? Command	164
15.3.3.	HTTP Client with #SD	166
15.3.4.	FTP File Uploading	167
15.3.5.	E-mail with no Attachment	169
15.3.6.	Modules in Server and Client Configuration	170
16.	DIALUP CONNECTION	174
16.1.	Examples	174
16.1.1.	Start PPP Protocol	174
16.1.2.	Dial-up Using <cid>=1 by default (2G)	175
16.1.3.	Dial-up Using <cid>=1 by default (3G)	176
16.1.4.	4G Modules	177
16.1.4.1.	Dial-up & #DUALAPN Command (Platform Version ID 20)	177
16.1.4.2.	Dial-up & #DUALAPN Command (Platform Version ID 20)	179
16.1.4.3.	Dial-up Command, Platform Version ID 25, 30, 37	181
17.	APPENDIX	182
17.1.	IPv6 Protocol	182
17.1.1.	2G Modules	182
17.1.2.	3G Modules	183

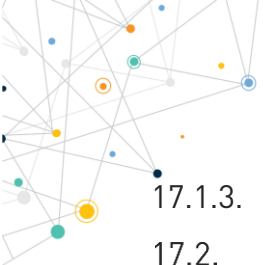

17.1.3.	4G Modules	183
17.2.	IPv4, IPv6 and Dual Stack	183
17.2.1.	2G/3G/4G Modules	183
17.2.2.	3G/4G Modules	185
17.3.	IPv6 Notation	186
17.3.1.	+CGPIAF Command	186
17.4.	Examples	187
17.4.1.	+CGDCONT Command & IPV6 Notation	187
17.4.2.	#SD Command & IPV6 Notation	187
17.4.3.	#FTPOPEN Command & IPV6 Notation	188
17.4.4.	#PING Command & IPV6 Notation	188
17.4.5.	#DNS Command & IPV6 Notation	188
17.4.6.	#FRWLIPV6 Command & IPV6 Notation	189
17.5.	#NCN Command	189
17.5.1.	#NCM Command, Mode=1	189
17.5.2.	#NCM Command, Mode=2	191
17.6.	#MBIMCFG Command	193
17.6.1.	Modules: LE910 Series	193
17.6.2.	Modules: LE910-SV1, -SVL, SV V2	194
17.7.	#NWMODE Command	194
17.8.	Obsolete Commands	197
18.	PRODUCT AND SAFETY INFORMATION	199
18.1.	Copyrights and Other Notices	199
18.1.1.	Copyrights	199
18.1.2.	Computer Software Copyrights	199
18.2.	Usage and Disclosure Restrictions	200
18.2.1.	License Agreements	200
18.2.2.	Copyrighted Materials	200
18.2.3.	High Risk Materials	200
18.2.4.	Trademarks	200
18.2.5.	3rd Party Rights	201
18.2.6.	Waiver of Liability	201

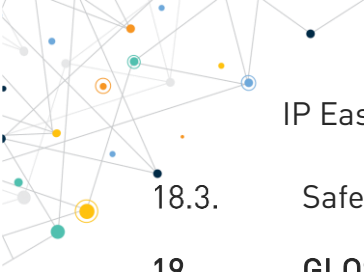

18.3.	Safety Recommendations	201
19.	GLOSSARY	203
20.	DOCUMENT HISTORY	204



Figures List

Figure 1: PSD Connection	19
Figure 2: Example of Ports Config. and Skt Distribution	19
Figure 3: Example of CMUX and Socket Distribution	20
Figure 4: Switching from COMMAND to ONLINE mode	21
Figure 5: Assigned APN and Network Interfaces	48
Figure 6: LE910-EU1, Multi/Protocol/Internal Sockets, and Network Interface	102
Figure 7: Assigned APN does not Support Data Traffic	142
Figure 8: User APN Supports Data Traffic	143
Figure 9: GSM CSD Call	160
Figure 10: GPRS Dialup Connection	174
Figure 11: Dialup Connection using <cid>=2	178
Figure 12: IPv4	185
Figure 13: IPv6	185
Figure 14: Dual IP Stack IPv4v6	186

Tables List

<i>Tab. 1: 2G/3G Context Types</i>	22
<i>Tab. 2: 2G/3G Default Sockets/Contexts Binding Configuration & PDP State</i>	24
<i>Tab. 3: Example of PDP Contexts Configuration</i>	30
<i>Tab. 4: 2G/3G Default Sockets/Contexts Binding Configuration</i>	66
<i>Tab. 5: 2G/3G Sockets/Contexts Binding Configuration</i>	67
<i>Tab. 6: LE910-EU1, Network Operator Service & Multi-Socket</i>	68
<i>Tab. 7: LE910-SV1, IMS, ADMIN, INTERNET Services & Multi-Socket</i>	70
<i>Tab. 8: LE866-SV1, IMS, ADMIN, INTERNET Services & Multi-Socket</i>	71
<i>Tab. 9: Sockets/Contexts Binding and PDPs Active</i>	73
<i>Tab. 10: Sockets/Contexts Binding and Sockets Opened</i>	74
<i>Tab. 11: An Example of Sockets in Listening Mode</i>	80
<i>Tab. 12: 2G/3G Multi-Socket & Protocol Sockets</i>	99
<i>Tab. 13: LE910-EU1, Network Operator Service, Multi-Socket and Protocols</i>	101
<i>Tab. 14: LE910-SV1, IMS, ADMIN, INTERNET Services, Multi-Socket and Protocols</i>	103
<i>Tab. 15: LE910Cx, Network Operator Service, Multi-Socket and Protocols</i>	105
<i>Tab. 16: 2G Multi-Socket & HTTP Service Socket</i>	107
<i>Tab. 17: 3G Multi-Socket & HTTP Service Socket</i>	108
<i>Tab. 18: 2G Multi-Socket & SMTP Service Socket</i>	119
<i>Tab. 19: 3G Multi-Socket & SMTP Service Socket</i>	120
<i>Tab. 20: 2G/3G Multi-Socket & FTP Service Socket</i>	128
<i>Tab. 21: 2G/3G Multi-Socket & FTP Service Socket Opened</i>	131
<i>Tab. 22: 2G/3G Multi-Socket & PING Service Socket</i>	157
<i>Tab. 23: Platform Version ID & IPV4/IPV6 Addresses</i>	182
<i>Tab. 24: Obsolete and New AT Commands</i>	197

AT Commands List

The following list, organized in alphabetical order, shows the AT commands covered by this User Guide. The number close to each command indicates the page of the first AT command occurrence.

AT#BASE64	78	AT#MQCFG	145	AT#SI	91
AT#CEERNET	56	AT#MQCFG2	146	AT#SKIPESC	78
AT#CGPADDR	32	AT#MQCONN	148	AT#SL	80
AT#DNS	188	AT#MQDISC	148	AT#SLASTCLOSURE	77
AT#DUALAPN	54	AT#MQEN	144	AT#SLUDP	82
AT#EADDR	122	AT#MQPUBS	151	AT#SMTPCFG	118
AT#EMAILD	121	AT#MQREAD	153	AT#SMTPCL	121
AT#EPASSW	122	AT#MQSUB	151	AT#SO	75
AT#ESMTP	122	AT#MQTCFG	147	AT#SRECV	90
AT#EUSER	122	AT#MQUNS	152	AT#SS	82
AT#FRWL	83	AT#MQWCFG	147	AT#SSEND	90
AT#FTPAPP	133	AT#NCM	47	AT#SSENDEXT	90
AT#FTPAPPEXT	132	AT#NWMODE	179	AT#TCPMAXDAT	77
AT#FTPCLOSE	128	AT#PADCMD	74	AT#TCPREASS	77
AT#FTPGET	136	AT#PADFWD	75	AT+CGACT	32
AT#FTPGETPKT	136	AT#PDPAUTH	63	AT+CGATT	30
AT#FTPOPEN	127	AT#PING	157	AT+CGAUTH	64
AT#FTPPUT	132	AT#PROTOCOLCFG	100	AT+CGCONTRDP	40
AT#FTPPWD	138	AT#SA	81	AT+CGDCONT	22
AT#FTPREST	137	AT#SCFG	19	AT+CGPADDR	55
AT#FTPTO	131	AT#SCFGEXT	88	AT+CGPIAF	186
AT#FTPTYPE	132	AT#SCFGEXT2	89	AT+CGQMIN	34
AT#GSMCONT	22	AT#SD	32	AT+CGQREQ	36
AT#HTTPCFG	106	AT#SGACT	34	AT+CMEE	26
AT#HTTPQRY	111	AT#SGACTAUTH	28	AT+COPS	55
AT#HTTPRCV	113	AT#SGACTCFG	28	AT+WS46	176
AT#HTTPSND	112	AT#SGACTCFGEXT	28	ATD	47
AT#ICMP	157	AT#SH	76		

1. INTRODUCTION

1.1. Scope

This document illustrates the set of AT commands used to manage IP Easy features. Reading these pages, it is suggested to refer to the AT Command Reference Guide according to the product you are using (2G/3G/4G). The present guide describes the use of the AT commands through examples.

1.2. Audience

The reader is expected to have experience in 2G/3G/4G technologies as well as in Telit's AT Commands interface.

1.3. Contact Information, Support

For general contact, technical support services, technical questions and report of documentation errors contact Telit Technical Support at:

- TS-EMEA@telit.com
- TS-AMERICAS@telit.com
- TS-APAC@telit.com
- TS-SRD@telit.com
- TS-ONEEDGE@telit.com

Alternatively, use:

<https://www.telit.com/contact-us/>

For detailed information about where you can buy the Telit modules or for recommendations on accessories and components visit:

<https://www.telit.com/>

Our aim is to make this guide as helpful as possible. Keep us informed of your comments and suggestions for improvements.

Telit appreciates the user feedback on our information.

1.4. Symbol Convention



Danger: This information **MUST** be followed or catastrophic equipment failure or personal injury may occur.



Warning: Alerts the user on important steps about the module integration.



Note/Tip: Provides advice and suggestions that may be useful when integrating the module.



Electro-static Discharge: Notifies the user to take proper grounding precautions before handling the product.

Table 1: Symbol Conventions

All dates are in ISO 8601 format, that is. YYYY-MM-DD.

1.5. Related Documents

- [1] AT Commands Reference Guide, 80000ST10025a
- [2] Telit 3G Modules AT Commands Reference Guide, 80378ST10091A
- [3] Telit's Modules Software User Guide, 1w0300784
- [4] LE910 V2 Series AT Commands Reference Guide, 80446ST10707A
- [5] SSL/TLS Users Guide, 1w0300989
- [6] Telit CMUX Implementation User Guide, 1w0300994
- [7] Telit 3G Modules Ports Arrangements User Guide, 1w0300971
- [8] GE910 Series Ports Arrangements User Guide, 1w0301049
- [9] LE910 V2, LE910 Cat1 NCM Protocol User Guide, 1w0301246
- [10] LE910 V2, LE910 Cat1 Ports Arrangements User Guide, 1w0301252
- [11] LE/ME 866 Series AT Commands Reference Guide, 80471ST10691A
LE866-SV1/LE866A1-NA AT Commands Reference Guide, 80471ST10691A
- [12] LE866, ME866A1 Ports Arrangements User Guide, 1w0301469
- [13] LE910Cx AT Commands Reference Guide, 80502ST10950A
- [14] ME910C1/ML865C1 AT Commands Reference Guide, 80529ST10815A
- [15] ME310G1/ME910G1/ML865G1 AT Commands Reference Guide, 80617ST10991A

2. PRELIMINARY INFORMATION

The AT commands covered by this guide are not described with an exhaustive list of their parameters and their related meanings, the guide gives more space to examples describing the major concepts about the IP Easy features.



To get information on AT commands syntax and related parameters, refer to the AT Command Reference Guide according to the module you are using, see chapter 1.5

3. IP EASY FEATURES

Telit modules provide a set of communication features accessible to the user through AT commands. This environment is a software layer based on the TCP/IP protocol stack and a set of AT commands: it is called IP Easy. By means of these AT commands, the user device, connected through a serial line to the Telit module, exchanges data with a remote device on Internet network, refer to Fig. 1. Telit module establishes a connection over a radio interface using its internal TCP/IP protocol stack, and exchanges TCP/IP packets with the remote device. In this scenario, the user device does not need an own TCP/IP protocol stack.

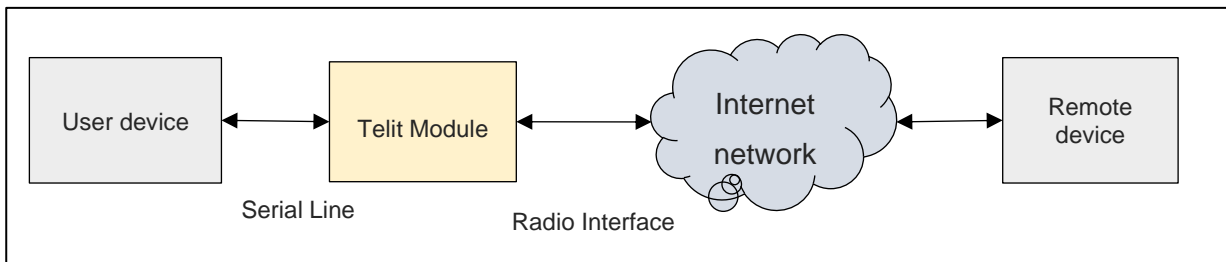

Figure 1: PSD Connection

IP Easy environment provides the following features:

Multi-socket environment.

It supports up to N sockets, the N value depends on the module you are using. To know the N value, use the AT#SCFG=? Test command. The N socket connections can be distributed over the available physical ports, as shown in Fig. 2 and Fig. 3.

The AT Commands Interfaces (AT Parsers: AT0, AT1, AT2) can work in COMMAND mode or in ONLINE mode. In COMMAND mode, the user can send AT commands which are parsed by the AT parser, and, on the same physical line, the user receives the AT commands responses.

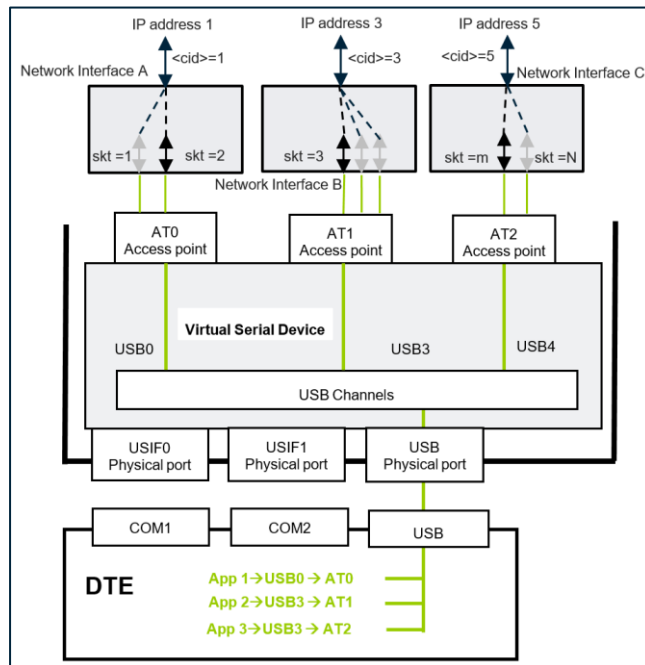

Figure 2: Example of Ports Config. and Skt Distribution

In ONLINE mode, the data entered by the user are forwarded on the current connection toward the remote host. The data sent by the remote host are forwarded, on the same physical line, to the user.

You can use #PORTCFG command to manage the physical ports configuration of the module. In Fig. 2 and Fig. 3 the gray rows indicate sockets that are open, working in background, and not exchanging data with the user. The black rows indicate the sockets that currently are exchanging data with the user.

The Fig. 3 shows an example using the #PORTCFG command and the CMUX tool (VC1, VC2, VC3):

- App 1 connected on VC1/AT0 manages two sockets. The picture shows the time interval in which socket=1 is suspended, and socket=2 is exchanging data with the user through AT0 Interface.
- App 2 connected on VC2/AT1 manages two sockets. The picture shows the time interval in which socket=4 is suspended, and socket=3 is exchanging data with the user through AT1 Interface. Note that the sockets belong to two different Network Interfaces, and the Network Interface can manage multiple sockets.
- App 3 connected on VC3/AT2 manages two sockets. The picture shows the time interval in which socket=5 is suspended, and socket=N is exchanging data with the user through AT2 Interface.

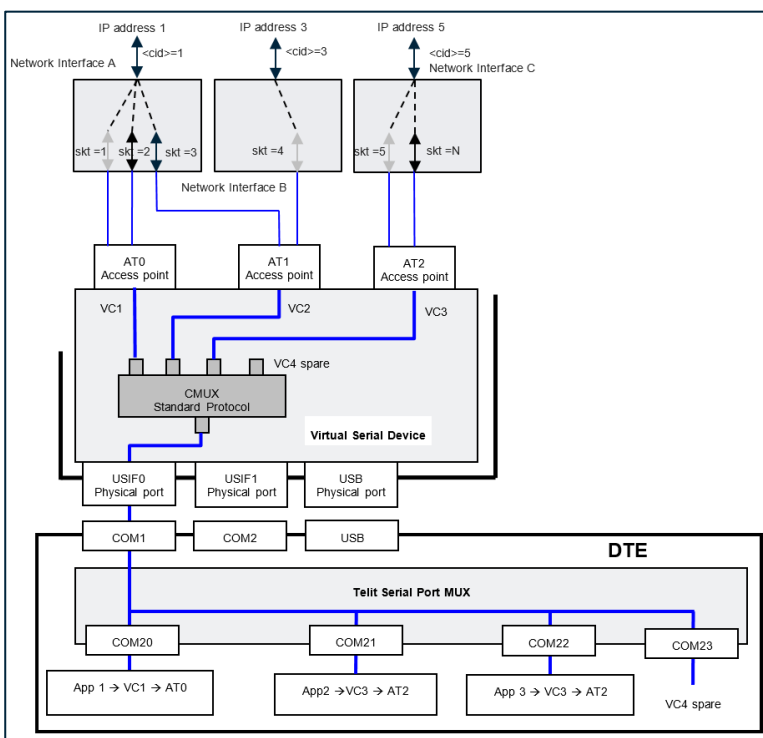

Figure 3: Example of CMUX and Socket Distribution

To have information on CMUX tool refer to document [6] and on #PORTCFG command refer to documents [7], [8], [10], [12], [13], [14] or [15] according to the module used.

PDP context number activated at the same time

The max number of the PDP context that can be defined (+CGDCONT command), and the max number of PDP contexts that can be activated at the same time (#SGACT command) depend on the module you are using. For each active PDP context, the network assigns to the module an IP address, see Fig. 2 and Fig. 3.

Socket

suspension/resumption

The ONLINE mode can be suspended with the escape sequence (+++), and the AT Interface enters COMMAND mode. During COMMAND mode, the data received from the remote host are buffered in the socket buffer.

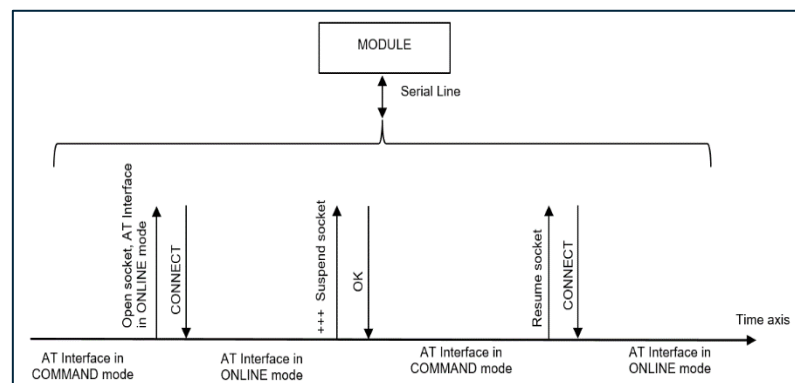

Figure 4: Switching from COMMAND to ONLINE mode

Data will be displayed on AT Interface after socket resumption (#SO command), see examples in chapters 8.7.1.

Simultaneous client Services

Multiple Multi-socket connections and simultaneous client Services, example FTP, can be opened. See example in chapter 12.3.1

4. 2G/3G MODULES

4.1. Context Types

The Tab. 1 shows the context types provided by the 2G/3G modules. Two different AT commands are used to define PDP and GSM contexts, but only one command (#SGACT) activates them.

PDP Context Multi-Socket environment <cid>≠0	GSM Context Used in CSD connection Only <cid>=0
AT+CGDCONT=<cid>,... AT#SGACT=<cid>,1	AT#GSMCONT=0,... AT#SGACT=0,1
Refer to next chapters	Refer to chapter 15

Tab. 1: 2G/3G Context Types

4.1.1. PDP Context Setting, +CGDCONT Command

Use +CGDCONT command to define a PDP context. The command syntax is:

```
AT+CGDCONT = [<cid>[,<PDP_type>[,<APN>[,<PDP_addr>[,<d_comp>
[,<h_comp>[,<pd1>[,...[,pdN]]]]]]]]]]
```

Here is an example of PDP context definition.

```
AT+CGDCONT= 1,"IP","Access_Point_Name","0.0.0.0",0,0
OK
```

Use the AT+CGDCONT=? test command to know the parameters ranges of the command. To get parameters descriptions refer to documents [1] or [2], according to the module used.

4.1.2. Example 2G

Assume to use a module belonging to Platform Version ID 10, 13, 16. Type in the AT+CGDCONT=? test command to get the supported parameters values. The returned message shows the <cid> range: **1-5** of the PDP contexts.

```
AT+CGDCONT=?
```

```
+CGDCONT: (1-5),"IP",,,(0,1),(0,1)
```

```
+CGDCONT: (1-5),"IPV6",,,(0,1),(0,1)
```

```
OK
```

4.1.3. Example 3G

Assume to use a module belonging to Platform Version ID 12. Type in the AT+CGDCONT=? test command to get the supported parameters values. The returned message shows the <cid> range: 1-5 of the PDP contexts.

```
AT+CGDCONT=?
```

```
+CGDCONT: (1-5),"IP",,,(0,1),(0,1)
```

```
+CGDCONT: (1-5),"IPV6",,,(0,1),(0,1)
```

```
+CGDCONT: (1-5),"IPV4V6",,,(0,1),(0,1)
```

```
OK
```

4.2. PDP Context Activation, #SGACT Command

The #SGACT command activates/deactivates one of the PDP contexts defined with +CGDCONT command. The command syntax is:

```
AT#SGACT= <cid>,<stat>[,<userId>,<pwd>]
```

Use the AT#SGACT=? test command to get the supported <cid> values range.

To get parameters descriptions, refer to documents [1] or [2], according to the module used.

```
AT#SGACT=?
```

```
#SGACT: (0-5),(0,1) ← <cid> range: 0-5
```

```
OK
```

The <cid>=0 is reserved for GSM context, refer to chapter 15.

Following table shows the five PDP contexts (identified by <cid>: 1-5) in not active state, and the default sockets/contexts binding configuration provided by the modules. Use the #SCFG command to manage the socket configuration, refer to chapter 6.1

IP Easy Multi-Socket <connId>	<cid>=1 Not active	<cid>=2 Not active	<cid>=3 Not active	<cid>=4 Not active	<cid>=5 Not active
1	bound	/	/	/	/
2	bound	/	/	/	/
3	bound	/	/	/	/
4	/	bound	/	/	/
5	/	bound	/	/	/
6	/	bound	/	/	/

Tab. 2: 2G/3G Default Sockets/Contexts Binding Configuration & PDP State

AT#SGACT=<cid>,1 activates the PDP context identified by the <cid>, and creates a Network Interface, related to the <cid>, to use the TCP/IP protocol running on the module. The Network Interface is the connection between the IP address, assigned to the module by the network, and the internal structure of the module

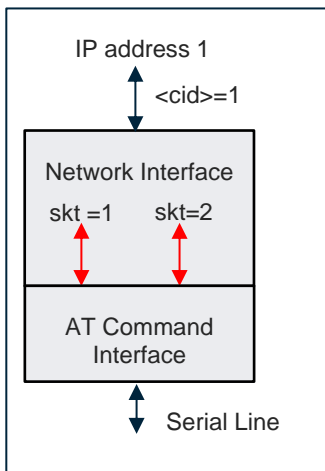

bind <cid>=1 to socket=1: AT#SCFG=1,1,...
 (see chapter 6.1)
 bind <cid>=1 to socket=2: AT#SCFG=2,1,...
 Activate <cid>=1: AT#SGACT=1,1
Note: the sockets are not open.

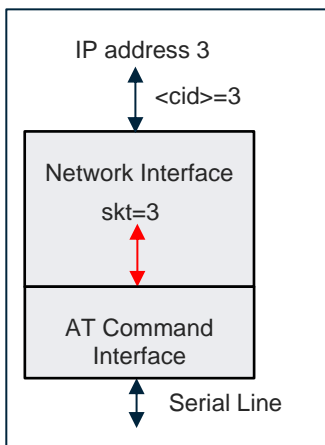

bind <cid>=3 to socket=3: **AT#SCFG=3,3,...**
 Activate <cid>=3: **AT#SGACT=3,1**
Note: the sockets are not open.

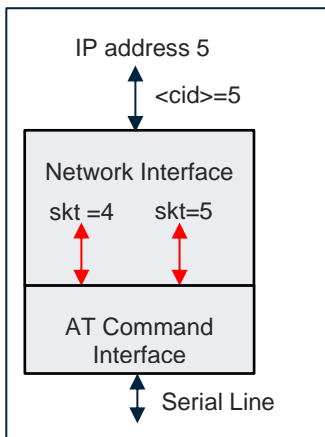

bind <cid>=5 to socket=4: **AT#SCFG=4,5,...**
 bind <cid>=1 to socket=2: **AT#SCFG=5,5,...**
 Activate <cid>=5: **AT#SGACT=5,1**
Note: the sockets are not open.

The command **AT#SGACT=<cid>,0** deletes the PDP context and its Network Interface.

4.2.1. Max Number of Active PDP Contexts

As stated in chapter 3, the max number of the PDP contexts that can be defined (+CGDCONT command), and the max number of PDP contexts that can be activated at the same time (#SGACT command) depend on the module you are using.

This example shows how to check the max number of PDP contexts that can be activated at the same time by the module under test.

Assume to use the HE910 module. It supports up to three active PDP contexts, for each active PDP context the network assigns to the module an IP address. This is valid for all modules having Platform Version ID = 12.

Check the module type under test.

AT+CGMM

HE910

OK

Enable ERROR report in verbose format.

AT+CMEE=2

OK

Check the current PDP contexts configuration.

AT+CGDCONT?

+CGDCONT: 1,"IP"," Access_Point_Name ","",0,0

+CGDCONT: 2,"IP"," Access_Point_Name ","",0,0

+CGDCONT: 3,"IP"," Access_Point_Name ","",0,0

+CGDCONT: 4,"IP"," Access_Point_Name ","",0,0

+CGDCONT: 5,"IP"," Access_Point_Name ","",0,0

OK

Check the current Multi-sockets/PDP contexts configuration.

AT#SCFG?

#SCFG: 1,5,300,90,600,50

#SCFG: 2,5,300,90,600,50

#SCFG: 3,4,300,90,600,50

#SCFG: 4,3,300,90,600,50

#SCFG: 5,2,300,90,600,50

#SCFG: 6,1,300,90,600,50

OK

Check if some PDP context is active. The following response shows that no PDP contexts are active.

AT#SGACT?

#SGACT: 1,0

#SGACT: 2,0

#SGACT: 3,0

#SGACT: 4,0

#SGACT: 5,0

OK

Activate PDP context identified by <cid>=1.

AT#SGACT=1,1

#SGACT: 2.192.12.25

OK

Activate PDP context identified by <cid>=2.

AT#SGACT=2,1

#SGACT: 2.192.17.170

OK

Activate PDP context identified by <cid>=3.

AT#SGACT=3,1

#SGACT: 2.192.20.171

OK

Check which are the active PDP contexts.

AT#SGACT?

#SGACT: 1,1

#SGACT: 2,1

#SGACT: 3,1

#SGACT: 4,0

#SGACT: 5,0

OK

Try to activate the fourth and fifth PDP context

AT#SGACT=4,1

+CME ERROR: activation failed

AT#SGACT=5,1

+CME ERROR: activation failed

4.2.2. Automatic Activation/Reactivation, #SGACTCFG Command

Use #SGACTCFG command to enable/disable the automatic activation/reactivation of the PDP context specified by the <cid> identifier. The PDP context is automatically activated after every:

- attach procedure
- network PDP context deactivation
- SIM removal

if at least one IP Easy socket has been configured to use the PDP context (see #SCFG). The command syntax is:

AT#SGACTCFG=<cid>,<retry>[,<delay>[,<urcmode>]]

To get parameters descriptions, refer to documents [1] or [2], according to the used module.

4.2.3. Abort Context Activation, #SGACTCFGEXT Command

Use #SGACTCFGEXT command to abort a context activation attempt. The command syntax is:

AT#SGACTCFGEXT=<cid>,<abortAttemptEnable>[,<unused>[,<unused>[,<unused>]]]

To get parameters descriptions, refer to documents [1] or [2], according to the module used.

4.2.4. Authentication Setting, #SGACTAUTH Command

Use #SGACTAUTH command to set authentication. The command syntax is:

AT#SGACTAUTH=<type>

To get parameters descriptions, refer to documents [1] or [2], according to the module used.

4.2.5. Examples

4.2.5.1. PDP Contexts and Sockets Bindings

Check the sockets/PDP contexts binding configuration. Refer to chapter 6.1 to get more information on #SCFG command. The following response shows the default configuration.

AT#SCFG?

#SCFG: 1,1,300,90,600,50

#SCFG: 2,1,300,90,600,50

#SCFG: 3,1,300,90,600,50

#SCFG: 4,2,300,90,600,50

#SCFG: 5,2,300,90,600,50

#SCFG: 6,2,300,90,600,50

OK

Before activating PDP contexts <cid>=3 and <cid>=4, bind the sockets <connId>=1 and <connId>=5 respectively to PDP contexts <cid>=3 and <cid>=4.

AT#SCFG = 1, 3, 300, 90, 600, 50

OK

AT#SCFG = 5, 4, 300, 90, 600, 50

OK

Check the new sockets/PDP contexts binding configuration.

AT#SCFG?

#SCFG: 1,3,300,90,600,50

#SCFG: 2,1,300,90,600,50

#SCFG: 3,1,300,90,600,50

#SCFG: 4,2,300,90,600,50

#SCFG: 5,4,300,90,600,50

#SCFG: 6,2,300,90,600,50

OK

Assume that the PDP contexts has been set as shown below.

AT+CGDCONT?

+CGDCONT: 3,"IP","Access_Point_Name ","0.0.0.0",0,0

+CGDCONT: 4,"IP","Access_Point_Name","0.0.0.0",0,0

OK

Check if the module is attached.

AT+CGATT?

+CGATT: 1 ← the module is attached.

OK

AT#SGACT = 3,1 ← activate the PDP context 3

#SGACT: 31.157.55.95

OK

AT#SGACT = 4,1 ← activate the PDP context 4

#SGACT: 31.159.34.186

OK

On success, the #SGACT command returns the IP address assigned to the module by the network. The user application can use the just received IP address for its targets. The PDP context deactivation frees the network resources.

The table below shows the new PDP contexts configuration.

IP Easy Multi-Socket <connId>	<cid>=1 Not active	<cid>=2 Not active	<cid>=3 Active	<cid>=4 Active	<cid>=5 Not active
1	/	/	bound	/	/
2	bound	/	/	/	/
3	bound	/	/	/	/
4	/	bound	/	/	/
5	/	/	/	bound	/
6	/	bound	/	/	/

Tab. 3: Example of PDP Contexts Configuration

4.2.5.2. PDP Context Activation/Reactivation

Set activation/reactivation of PDP context <cid>=1, with 3 attempts.

```
AT#SGACTCFG=1,3
```

```
OK
```

Before using #SGACTCFG command, the <cid> must be connected to a socket, see AT#SCFG? read command

4.3. PDP Context Activation, +CGACT Command

The +CGACT command activates a PDP context defined by the +CGDCONT command, but the PDP context cannot be used with Multi-socket commands. Therefore, if you try to open a socket with #SD, you get an error message indicating “context not opened”.



It is recommended to use the command #SGACT instead of the command +CGACT.

See the following example.

Enable ERROR report in verbose format.

```
AT+CMEE=2
```

```
OK
```

Check the sockets/PDP contexts binding configuration.

```
AT#SCFG?
```

```
#SCFG: 1,1,300,90,600,50
```

```
#SCFG: 2,2,300,90,600,50
```

```
#SCFG: 3,2,300,90,600,50
```

```
#SCFG: 4,2,300,90,600,50
```

```
#SCFG: 5,2,300,90,600,50
```

```
#SCFG: 6,2,300,90,600,50
```

```
OK
```

Check the PDP contexts state.

```
AT#SGACT?
```

```
#SGACT: 0,0
```



```
#SGACT: 1,0
```

```
#SGACT: 2,0
```

```
OK
```

Activate the PDP context identified by <cid>=1.

```
AT+CGACT=1,1
```

```
OK
```

```
AT#SGACT?
```

```
#SGACT: 0,0
```

```
#SGACT: 1,1
```

```
#SGACT: 2,0
```

```
OK
```

Open the connection.

```
AT#SD=1,0,20510,"server_address",0,0,1
```

```
+CME ERROR: context not opened
```

4.4. IP Address Information, #CGPADDR Command

Once activated the PDP or GSM¹ context, to get the IP address assigned by the network to the module, use #CGPADDR command. If no <cid> are specified, it reports the addresses for all activated contexts.

- <cid>=0 identifies the GSM context
- <cid>=1-5 identify PDP contexts

```
AT#CGPADDR= [<cid>[,<cid>[,...]]]
```

To get parameters descriptions refer to documents [1] or [2] according to the used module.

¹ Refer to chapter 15

Check the defined PDP contexts.

AT+CGDCONT?

```
+CGDCONT: 1,"IP","Access_Point_Name","0.0.0.0",0,0
+CGDCONT: 2,"IP","Access_Point_Name","0.0.0.0",0,0
+CGDCONT: 3,"IP","Access_Point_Name","0.0.0.0",0,0
+CGDCONT: 4,"IP","Access_Point_Name","0.0.0.0",0,0
+CGDCONT: 5,"IP","Access_Point_Name","0.0.0.0",0,0
OK
```

Check the defined GSM context.

AT#GSMCONT?

```
#GSMCONT: 0,"IP","ISP_phone_number"
OK
```

Use AT#CGPADDR=? test command to check which <cid> are defined.

AT#CGPADDR=?

```
#CGPADDR: (0,1,2,3,4,5)
OK
```

Remove GSM context identified by <cid>=0

AT#GSMCONT=0

OK

Remove PDP context identified by <cid>=3

AT+CGDCONT=3

OK

Use AT#CGPADDR=? test command to check the new group of defined <cid>.

AT#CGPADDR=?

```
#CGPADDR: (1,2,4,5)
OK
```

Define GSM context. Refer to chapter 15.

```
AT#GSMCONT=0,"IP","ISP_phone_number"
```

```
OK
```

Activate the GSM context. The command returns the IP address assigned by the network to the module.

```
AT#SGACT = 0,1
```

```
#SGACT: "10.137.93.60"
```

```
OK
```

Get the IP address associated to the GSM context.

```
AT#CGPADDR = 0
```

```
#CGPADDR: 0,"10.137.93.60"
```

```
OK
```

4.5. QoS Setting (2G/3G)

4.5.1. Minimum QoS Setting, +CGQMIN Command

Use the +CGQMIN command to specify the minimum QoS profile under which the 2G connection quality is no longer acceptable, and the connection will be terminated. The command syntax is:

```
AT+CGQMIN=[<cid>[,<precedence>[,<delay>[,<reliability>[,<peak>[,<mean>]]]]]]
```

Refer to documents [1] or [2] to get parameters descriptions. In addition, refer to standards 3GPP TS 27.007, 3GPP TS 23.107, and 3GPP TS 03.60 (Release 1998).

NOTE:

- I. The +CGQMIN command can modify the 3G QoS according to 3GPP 23.107.
- II. If the minimum requirements are too high, PDP activation could be impossible due to the lack of the network resources needed to guarantee the required QoS. In this case, the minimum quality requirements must be reduced. It is suggested to use the default setting values.

4.5.1.1. Examples 2G

Here are two examples.

Example 1

Assume to use a module belonging to Platform Version ID 16. Suppose that the PDP context has been already defined and identified by <cid>=1. Now, bind the PDP context <cid>=1 to the desired minimum QoS profile.

AT+CGQMIN= 1,2,0,0,5,4

OK

Use AT+CGQMIN=? test command to check the supported value of the PDP type and the values ranges of all other parameters. Currently is supported only the "IP" Packet Data Protocol type.

AT+CGQMIN=?

+CGQMIN: "IP",(0-3),(0-4),(0-5),(0-9),(0-18,31)

OK

Example 2

Assume to use a module belonging to Platform Version ID 16.

Check the already defined PDP contexts.

AT+CGDCONT?

+CGDCONT: 1,"IP","Access_Point_Name","",0,0

+CGDCONT: 2,"IP","Access_Point_Name","",0,0

+CGDCONT: 3,"IP","Access_Point_Name","",0,0

OK

Check the QoS of the defined PDP contexts.

AT+CGQMIN?

+CGQMIN: 1,0,0,0,0,0

+CGQMIN: 2,0,0,0,0,0

+CGQMIN: 3,0,0,0,0,0

OK

Remove the PDP context <cid>=2.

AT+CGDCONT=2

OK

Check the remained PDP contexts.

AT+CGDCONT?

```
+CGDCONT: 1,"IP","Access_Point_Name","",0,0
```

```
+CGDCONT: 3,"IP","Access_Point_Name","",0,0
```

OK

Check the QoS of the remained PDP contexts

AT+CGQMIN?

```
+CGQMIN: 1,0,0,0,0,0
```

```
+CGQMIN: 3,0,0,0,0,0
```

OK

4.5.2. Required QoS Setting, +CGQREQ Command

This Use the +CGQREQ command to specify the required QoS profile to the 2G network. The QoS profile will be used when the PDP context is activated. The command syntax is:

AT+CGQREQ = [<cid>[,<precedence>[,<delay>[,<reliability>[,<peak>[,<mean>]]]]]]

Refer to documents [1] or [2] to get parameters descriptions. In addition, refer to standards 3GPP TS 27.007, 3GPP TS 23.107, 3GPP TS 03.60 (Release 1998).

NOTE:

- I. The +CGQREQ command can modify the 3G QoS according to 3GPP 23.107.
- II. It is suggested to use the default setting values.

Check the requested QoS of the defined PDP contexts

AT+CGQREQ?

```
+CGQREQ: 1,0,0,0,0,0
```

```
+CGQREQ: 3,0,0,0,0,0
```

OK

Modify the requested QoS bound to PDP context <cid>=1

AT+CGQREQ= 1,1,0,0,0,31

5. 4G MODULES

In GPRS and 3G networks, the data session is established by means of the Packet Data Protocol (PDP) Context procedure. Before the PDP context is established, the module performs the attach procedure, which communicates to the network that the module is powered on. After the attach procedure is completed, the module can do the first PDP Context procedure that will establish the data session and allocate an IP address to the module. This PDP Context will have a QoS associated with it, based on the current needs. If the module needs to have multiple data sessions, it will do a second PDP Context activation.

In LTE (4G) modules there are two types of data session setups.

- **Default Evolved Packet System (EPS) Bearer.**

When module attaches to the network at power on, it will be assigned default bearer that remains if module is attached. The default bearer will only support a nominal QoS (non-GBR bearer), but that should be enough for services not requiring GBR. Module can have additional default bearer as well. Each default bearer comes with a separate IP address. When the module needs to establish a service with a required QoS, a dedicated bearer will be established. This will have the QoS requirements needed for the service.

- **Dedicated Evolved Packet System (EPS) Bearer.**

Dedicated bearer is created when the requested service cannot be fulfilled through default bearer. Some services require a high level of QoS like VoIP, video etc. In this case, a dedicated bearer will be established with required QoS (can be GBR or non-GBR). Dedicated bearer does not require separate IP address, only additional default bearer needs an IP address and therefore dedicated bearer is always linked to one of the default bearers established previously. It is possible activate in dynamic mode or contextually at the default bearer one or more bearers dedicated to specific services.

5.1. Default EPS Bearer at Power ON

Assume to use the module LE910-EU1 (Platform Version ID 20). The following example shows that the PDP context <cid>=1 has not defined the Access Point Name (default configuration). During the attach procedure, the network assigns to the module the Default EPS Bearer that supports the services provided by the used Network Operator.

On the right side, for comparison, is also used a module having the Platform Version ID 13.

Power on the LE910-EU1 module (4G).

By default, the PDP context <cid>=1 has not defined APN.

AT+CGDCONT?

```
+CGDCONT: 1,"IPV4V6","","",0,0
```

OK

When the network recognizes the attach request with a not defined APN, the network assigns to <cid>=1 its Default EPS Bearer. The module is 4G attached.

AT+CGATT?

```
+CGATT: 1
```

OK

After the Attach procedure, the <cid>=1 identifies the Default EPS Bearer assigned by the network, and it is automatically activated.

AT+CGACT?

```
+CGACT: 1,1
```

OK

Power on a GE910-QUAD module (2G).

By default, the PDP context <cid>=1 is not defined.

AT+CGDCONT?

```
OK
```

The module is GPRS attached (2G).

AT+CGATT?

```
+CGATT: 1
```

OK

After the attached procedure, no PDP Contexts are active.

AT+CGACT?

```
OK
```

Power on the LE910-EU1 module (4G) - continued

List the dynamic parameters regarding the Default EPS Bearer assigned by the network and associated to <cid>=1 context identifier.

AT+CGCONTRDP=1

```
+CGCONTRDP:
```

```
1,          cid
5,          bearer_id
```

Power on the LE910-EU1 module (4G) - continued

```
"APN_Assigned_by_Network", APN
"10.178.43.36.255.0.0.0",      ip_addr and subnet_mask
"10.178.43.37",             gw_addr
"213.230.129.10",          DNS_prim_addr
"0.0.0.0",                  DNS_sec_addr
"0.0.0.0",                  P_CSCF_prim_addr
"0.0.0.0"                   P_CSCF_sec_addr
OK
```

NOTE

- I. The services (for example: IMS, Internet, etc.) provided by the Default EPS Bearer depend on the Network Operator.
- II. When the PDP context identified by <cid>=1 is set with user APN, it is used by the module during the 4G attachment and data connection procedures. Some Network Operators could not allow the 4G attachment when a user APN is used, therefore the network forces a detach procedure. If this happens, it is recommended to set the user APN on a PDP context identified by a <cid> different from 1 and keep on <cid>=1 the empty APN. To define a user APN, refer to chapter 5.5.



It is suggested to leave <cid>=1 to the Network Operator activities (attach procedure, IMS registration, ...), and use for own activities the others available <cid>.

At module power on, some Network Operators provide an APN that supports Internet.

5.2. PDP Context Setting, +CGDCONT Command

5.2.1. Platform Version ID 20

Use +CGDCONT command to define a PDP context according to the note II of chapter 5.1. To get information on the command syntax and its parameters refer to document [4].

```
AT+CGDCONT=[<cid>[,<PDP_type>[,<APN>[,<PDP_addr>[,<d_comp>
    [,<h_comp>[,<IPv4AddrAlloc>[,<emergency_indication>
    [,<P-CSCF_discovery>[,<IM_CN_Signalling_Flag_Ind>]]]]]]]]]]]
```

Refer to document [4].

5.2.1.1. Modules: LE910 Series

Modules: LE910-EU1, B1-EU, -JN1, -NA1, B1-NA, B1-SA, -NA V2, B4-NA, -EU V2, AU V2

Use the AT+CGDCONT=? test command to get the range of the supported values. <cid> range: 1-15.

AT+CGDCONT=?

```
+CGDCONT: (1-15),"IP" ,,,0,(0-4),(0,1),(0,1),(0,1),(0,1)
+CGDCONT: (1-15),"IPV6" ,,,0,(0-4),(0,1),(0,1),(0,1),(0,1)
+CGDCONT: (1-15),"IPV4V6" ,,,0,(0-4),(0,1),(0,1),(0,1),(0,1)
```

OK

Use the AT+CGDCONT? read command to get the current PDP contexts configurations. The following is the default configuration.

AT+CGDCONT?

```
+CGDCONT: 1,"IPV4V6","", "",0,0
```

OK

This module provides a set of 15 <cid> (1-15). By default, the <cid>=1 is dedicated to the Default EPS Bearers. For more information about the socket/PDP context binding, refer to chapter 6.1.2.1.1.

5.2.1.2. Modules: LE910-SV1, -SVL, SV V2

Use the AT+CGDCONT=? test command to get the ranges of the supported values. <cid> range: 1-6.

AT+CGDCONT=?

```
+CGDCONT: (1-6),"IP" ,,,0,(0-4),(0,1),(0,1),(0,1),(0,1)
+CGDCONT: (1-6),"IPV6" ,,,0,(0-4),(0,1),(0,1),(0,1),(0,1)
+CGDCONT: (1-6),"IPV4V6" ,,,0,(0-4),(0,1),(0,1),(0,1),(0,1)
```

OK

Use the AT+CGDCONT? read command to get the current PDN connections configurations. The following is the default configuration.

AT+CGDCONT?

+CGDCONT: 1,"IPV4V6","vzwims", "",0,0	Service: IMS
+CGDCONT: 2,"IPV4V6","vzadmin", "",0,0	Service: ADMIN
+CGDCONT: 3,"IPV4V6","vzwinternet", "",0,0	Service: INTERNET
+CGDCONT: 4,"IPV4V6","vzwapp", "",0,0	Unused
+CGDCONT: 5,"IPV4V6","vzw800", "",0,0	Unused
+CGDCONT: 6,"IPV4V6","vzwclass6", "",0,0	Service: INTERNET

OK

For PDN connections identified by <cid>=1 and <cid>=2, PDP Type and APN name cannot be changed. Refer to the following example.

Enable error report in verbose format.

AT+CMEE=2

OK

Try to change PDP Type and APN name

AT+CGDCONT=1,"IP","Access_Point_Name"

+CME ERROR: operation not allowed

Try to change PDP Type and APN name

AT+CGDCONT=2,"IP","Access_Point_Name"

+CME ERROR: operation not allowed

For more information about the socket/PDN context binding, refer to chapter 6.1.2.1.2.

5.2.2. Platform Version ID 23

Use +CGDCONT command to define a PDN connection according to the note II of chapter 5.1. To get information on the command syntax and its parameters refer to document [11].

AT+CGDCONT=[<cid>[,<PDP_type>[,<APN>]]]

Refer to document [11].

5.2.2.1. Modules: LE866-SV1, ME866A1-NV

Use the AT+CGDCONT=? test command to get the range of the supported values. <cid> range is 1-4.

AT+CGDCONT=?

```
+CGDCONT: (1-4),"IP",,,0,(0-4),(0,1),(0,1),(0,1),(0,1)
+CGDCONT: (1-4),"IPV6",,,0,(0-4),(0,1),(0,1),(0,1),(0,1)
+CGDCONT: (1-4),"IPV4V6",,,0,(0-4),(0,1),(0,1),(0,1),(0,1)
OK
```

Use the AT+CGDCONT? read command to get the current PDN connections configuration. The following is the default configuration.

AT+CGDCONT?

```
+CGDCONT: 1,"IPV4V6","vzwims",,,,,0,0,0,0,1,0 Service: IMS
+CGDCONT: 2,"IPV4V6","vzwadmin",,,,,0,0 Service: ADMIN
+CGDCONT: 3,"IPV4V6","vzwinternet",,,,,0,0 Service: INTERNET
OK
```

For PDN connections identified by <cid>=1 and <cid>=2, PDP Type and APN name cannot be changed. Refer to the following example.

Enable error report in verbose format.

AT+CMEE=2

OK

Try to change PDP Type and APN name

```
AT+CGDCONT=1,"IP","Access_Point_Name"
```

+CME ERROR: operation not allowed

Try to change PDP Type and APN name

AT+CGDCONT=2,"IP","Access_Point_Name"

+CME ERROR: operation not allowed

For more information about the socket/PDN connection binding, refer to chapter 6.1.2.2.1

5.2.2.2. Modules: LE866A1-NA, -KK, -JS, -KS, ME866A1-NA

Use the AT+CGDCONT=? test command to get the range of the supported values.

AT+CGDCONT=?

+CGDCONT:

+CGDCONT:

.....

OK

Use the AT+CGDCONT? read command to get the current PDN connections configuration.

AT+CGDCONT?

+CGDCONT:

OK

Assume to use the LE866A1-NA module

AT+CGDCONT=?

+CGDCONT: (1-5),"IP",,,0,(0-4),(0,1),(0,1),(0,1),(0,1)

+CGDCONT: (1-5),"IPV6",,,0,(0-4),(0,1),(0,1),(0,1),(0,1)

+CGDCONT: (1-5),"IPV4V6",,,0,(0-4),(0,1),(0,1),(0,1),(0,1)

OK

Use the AT+CGDCONT? read command to get the current PDN connections configuration.

AT+CGDCONT?

+CGDCONT: 1,"IPV4V6","broadband",,"",0,0

← default APN

OK



By default, modules LE866A1-NA, -KK, -JS, -KS, and ME866A1-NA support the Internet Service on <cid>=1.

5.2.3. Platform Version ID 25

Use +CGDCONT command to define a PDP context. The command syntax is:

```
AT+CGDCONT=[<cid>[,<PDP_type>[,<APN>[,<PDP_addr>[,<d_comp>[,<h_comp>
[,<IPv4AddrAlloc>[,<Emergency_ind>]]]]]]]]]
```

To get parameters descriptions, refer to documents [13].

5.2.3.1. Modules: LE910Cx Series

Here is an example of PDP context definition.

```
AT+CGDCONT= 1,"IP","Access_Point_Name","",0,0,0,0
OK
```

Use the AT+CGDCONT=? test command to know the parameters ranges of the command. Here are two examples.

Assume to use a module belonging to Platform Version ID 25. Type in the AT+CGDCONT=? test command to get the supported parameters values. The returned message shows the <cid> range: 1-24 of the PDP contexts.

```
AT+CGDCONT=?
+CGDCONT: (1-24),"IP",,,(0-2),(0-4),(0-1),(0-1)
+CGDCONT: (1-24),"PPP",,,(0-2),(0-4),(0-1),(0-1)
+CGDCONT: (1-24),"IPV6",,,(0-2),(0-4),(0-1),(0-1)
+CGDCONT: (1-24),"IPV4V6",,,(0-2),(0-4),(0-1),(0-1)
OK
```

5.2.4. Platform Version ID 30, 37

Use +CGDCONT command to define a PDP context. The command syntax is:

```
AT+CGDCONT=[<cid>[,<PDP_type>[,<APN>[,<PDP_addr>[,<d_comp>[,<h_comp>
[,<IPv4AddrAlloc>[,<emergencyIndication>]]]]]]]]]
```

To have detailed information about the +CGDCONT parameters refer to user guide [14] and [15] in accordance with the module used.

5.3. Establish a Default EPS Bearer

This chapter lists shortly the commands used to establish a Default EPS Bearer. They will be described in the next chapters.

AT+CGACT

Establishes a Default EPS Bearer. If the module is not attached, it does the attach procedure and then activates the Default EPS Bearer, does not create the Network Interface. See chapters 4.3, and 16.5.1.

AT#SGACT

Establishes a Default EPS Bearer and opens a Network Interface to use the TCP/IP protocol running on the module, refer to chapter 5.4.

ATD

Establishes a Default EPS Bearer. It provides a dialup connection, PPP protocol is used to exchange data between the PC (user device) and the module, the TCP/IP stack is running on the PC, see examples in chapter 15.1.

AT#NCM (in mode = 2)

Establishes a Default EPS Bearer, refer to chapter 17.5.

AT#MBIMCFG

Use this command to select the <cid> that will be used by MBIM tool running, for example, on the Windows-PC. The MBIM tool provides a "button" to establish the connection.



Platform Version ID 20:

AT#SGACT, AT+CGACT, ATD, NCM, and NBIM cannot use the same <cid> at the same time. The commands are mutually exclusive.

Platform Version ID 23 and 25:

AT#NCM and AT#MBIMCFG are not supported

5.4. PDP Context Activation, #SGACT Command

The #SGACT command activates/deactivates PDP contexts defined with +CGDCONT command. The #SGACT establishes a Default EPS Bearer and opens a Network Interface to use the TCP/IP stack running on the module. If the <cid> used by the #SGACT command is already active (as the result of the default bearer context activation procedure that can be part of the attach procedure, see next paragraph), the command opens only a Network Interface, see chapter 12.11.3.

During the attach procedure, the network automatically assigns to the module an APN, supporting some services, and an IP address. The module identifies these parameters with <cid>=1 identifier. This operation, at user level, is equivalent to enter manually the command AT+CGACT=1,1, which establishes a Default EPS Bearer, and does not create a Network Interface associated to <cid>=1. It is responsibility of the user to use the assigned address for a service (IMS, data traffic, etc.) in accordance with the assigned APN, see the example in chapter 12.11.3.

The Fig. 5 shows the concepts described above.

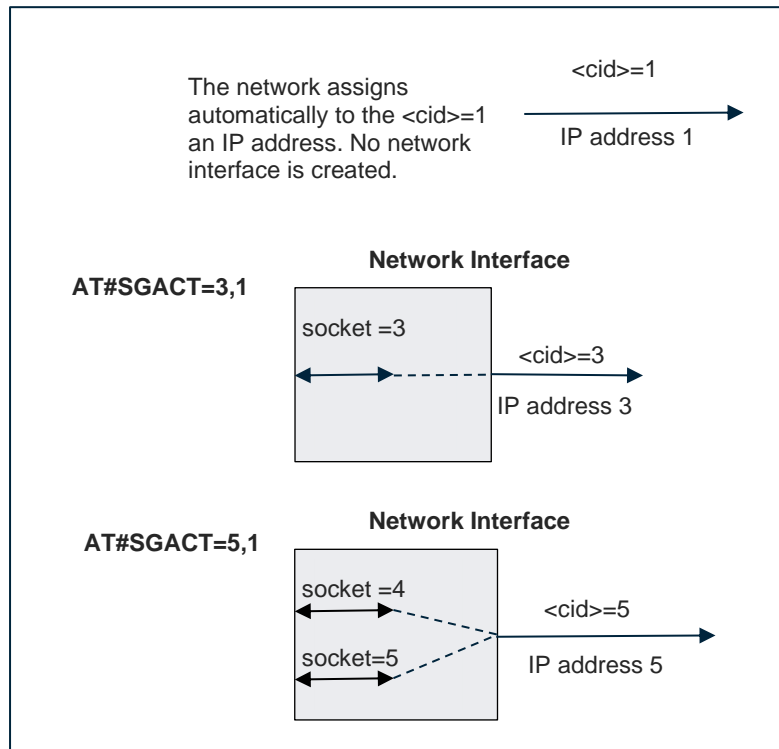

Figure 5: Assigned APN and Network Interfaces

5.4.1. Max Number of Active PDP Contexts

As stated in chapter 3, the max number of the PDP context that can be defined (+CGDCONT command), and the max number of PDP contexts that can be activated at the same time (#SGACT command) depend on the module you are using.

The example in chapter 4.2.1 shows a guideline, also for 4G modules, to check the max number of PDP contexts that can be activated at the same time.

5.4.2. Platform Version ID 20

The #SGACT command activates/deactivates PDP contexts defined with +CGDCONT command. To get information on the command syntax and its parameters refer to document [4].

AT#SGACT= <cid>,<stat>[,<userId>,<pwd>]

Use the AT#SGACT=? test command to know the parameters ranges of the command supported by the module that you are using. See next chapters.

5.4.2.1. Modules: LE910 Series

Modules: LE910-EU1, B1-EU, -JN1, -NA1, B1-NA, B1-SA, -NA V2, B4-NA, -EU V2, AU V2

Type in the AT+SGACT=? test command to get the <cid> parameter values range.

```
AT#SGACT=?  
#SGACT: (0-15),(0,1)  
OK
```

The return message shows the <cid> range: 0-15.

<cid>= 0 is reserved for GSM context, refer to chapter 15.

<cid>= 1 ÷ 15 are used for PDP contexts, see Tab. 13

Type in the AT#GSMCONT=? test command to verify the GSM context configuration.

```
AT#GSMCONT=?  
#GSMCONT: 0,"IP",  
OK
```

5.4.2.2. Modules: LE910-SV1, -SVL, SV V2

Type in the AT+SGACT=? test command to get the supported <cid> parameter values range.

```
AT#SGACT=?  
#SGACT: (0-15),(0,1)  
OK
```

The returned message shows the <cid> range: 0-15.

<cid>= 0 is not used.

<cid>= 1-15 are used for PDP contexts, see Tab. 14

5.4.3. Platform Version ID 23, 25

The #SGACT command activates/deactivates PDN connection defined with +CGDCONT command. To get information on the command syntax and its parameters refer to document [11] or [13].

```
AT#SGACT= <cid>,<stat>[,<userId>,<pwd>]
```

Use the AT#SGACT=? test command to know the parameters ranges of the command supported by the module that you are using. See next chapter.

5.4.3.1. Platform Version ID 23

5.4.3.1.1. Modules: LE866-SV1, ME866A1-NV

Type in the AT+SGACT=? test command to get the <cid> parameter values range.

```
AT#SGACT=?
```

```
#SGACT: {1-4},{0,1}
OK
```

The return message shows the <cid> parameter values range: 1-4, see Tab. 14.

5.4.3.2. Platform Version ID 23, 25

5.4.3.2.1. Modules: LE866A1-NA, -KK, -JS, -KS, ME866A1-NA, LE910Cx

Type in the AT+SGACT=? test command to get the <cid> parameter values range.

```
AT#SGACT=?
#SGACT: .....
OK
```

Assume to use the LE866A1-NA module.

```
AT#SGACT=?
#SGACT: {1-5},{0,1}
OK
```

5.4.4. Platform Version ID 30, 37

The #SGACT command activates/deactivates PDN connection defined with +CGDCONT command. To get information on the command syntax and its parameters refer to documents [14] and [15].

```
AT#SGACT=<cid>,<stat>[,<userId>[,<pwd>]]
```

Use the AT#SGACT=? test command to know the parameters ranges of the command supported by the module that you are using.

5.5. IP Address Information, #CGPADDR Command

Use #CGPADDR= command to verify the IP address assigned by the network to the modules after the PDP contexts activations.

```
AT#CGPADDR= [<cid>[,<cid>[,...]]]
```

To get parameters descriptions refer to documents [4], [11], [13], [14] or [15], according to the module used.

5.6. Change a Default EPS Bearer

Following these steps, you can substitute the Default EPS Bearer, assigned automatically to the <cid=1> by the Network Operator, with a user PDP Context defined through the +CGDCONT command.

Set up the user PDP Context identified by <cid>=1.

```
AT+CGDCONT=1,"IP","Access_Point_Name"
OK
```

Check the setting of the user PDP Context.

```
AT+CGDCONT?
+CGDCONT: 1,"IP","Access_Point_Name","",0,0
OK
```

Detach the module from the network.

```
AT+CGATT=0
OK
```

Attach the module. The new PDP Context associated to <cid>=1 is activated.

```
AT+CGATT=1
OK
```

Check the dynamic parameters of the PDP context assigned by the Network Operator in response of the user defined PDP context.

```
AT+CGCONTRDP=1
+CGCONTRDP:
1,          cid
5,          bearer_id
"Access_Point_Name.....", APN
"2.192.4.65.255.0.0.0", ip_addr and subnet_mask
"2.192.4.66", gw_addr
"10.207.43.46", DNS_prim_addr
"0.0.0.0", DNS_sec_addr
"0.0.0.0", P_CSCF_prim_addr
"0.0.0.0" P_CSCF_sec_addr
OK
```



To get parameters descriptions refer to documents [4], [11], [13], [14] or [15], according to the module used.

The module saves the Default EPS Bearer parameters in NVM. At each reboot, the Protocol Stack uses them.

Now, reboot the module.

Check if the module is attached.

AT+CGATT?

+CGATT: 1

OK

Check the user defined PDP context.

AT+CGDCONT?

+CGDCONT: 1,"IP","Access_Point_Name","",0,0

OK

Check the dynamic parameters of the PDP context assigned by the Network Operator in response of the user defined PDP context.

AT+CGCONTRDP=1

+CGCONTRDP:

1,

5,

"Access_Point_Name.....",

"2.192.16.112.255.0.0.0",

"2.192.16.113",

"10.207.43.46",

"0.0.0.0","0.0.0.0",

"0.0.0.0"

OK



To get parameters descriptions refer to documents [4], [11], [13], [14] or [15], according to the module used.

Remove the PDP context defined by the user.

AT+CGDCONT=1

OK

The <cid>=1 context identifier is associated again to a not defined APN (default).

AT+CGDCONT?

+CGDCONT: 1,"IPV4V6","", "",0,0

OK



Platform Versions ID 30, 37: to restore the default APN values to "" use AT#FWSWITCH, or set AT+CGDCONT=1,"IPV4V6","", ""

The module saves the new configuration in NVM. At each reboot, the Protocol Stack uses it.

Now, reboot the module and verify the dynamic parameters of the PDP Context.

The <cid>=1 context identifier is automatically associated to the Default EPS Bearer assigned by the Network Operator in response of the not defined APN (see +CGDCONT? command).

AT+CGCONTRDP=1

+CGCONTRDP:

1,

5,

"APN_Assigned_by_Network",

"10.178.48.185.255.0.0.0",

"10.178.48.186",

"213.230.129.10",

"0.0.0.0","0.0.0.0",

"0.0.0.0"

OK



Platform Version ID 25: AT+CGCONTRDP format is different. Only show the allocated information from the network, refer to document [13].

5.7. Dedicated EPS Bearer

As stated in chapter 5, some services like VoIP, video etc. require a high level of QoS. In this case, a dedicated bearer will be established with the required QoS (can be GBR or non-GBR). Generally, the dedicated bearer can be established either by the network or by the module.

Currently, Telit modules supports only the dedicated bearer establishment started by the network side and accepted by the user through, for example, the +CGANS command.

5.8. Multiple PDN, #DUALAPN Command

5.8.1. Platform Version ID 20

5.8.1.1. Modules: LE910 Series

Modules: LE910-EU1, B1-EU, -JN1, -NA1, B1-NA, B1-SA, -NA V2, B4-NA, -EU V2, AU V2

Suppose that the PDP contexts <cid>= 2 and <cid>=3 have the same APN and PDP type. If the module tries to activate both contexts, the second activation could fail because the second PDN Connectivity Request returns an ERROR message. This happens when the 4G Network Operator does not support multiple Default EPS bearers on a single APN. This could be a limitation for those user applications working with two different <cid> having the same APN and PDP type.

Telit has implemented the #DUALAPN command to provide a backward compatibility for the user applications mentioned previously. For example, you can assign to <cid>=3 the same APN and PDP type already in use with <cid>=2. The module routes the <cid>=3 to the <cid>=2, the result is that both <cid> have the same IP address. See the examples in the following sub-chapters. The command syntax is:

AT#DUALAPN=<mode>[,<UNUSED_1>[,<UNUSED_2>[,<UNUSED_3>]]]

Where

< mode > - mode:

0 - if the module tries to activate a PDP context having the same APN and PDP type used by another PDP context already in use, there is a “routing” to the PDP context already active. The IP address is the same, use +CGPADDR command to check it. It is the default mode.

1 - if the module tries to activate a PDP context having the same APN and PDP type used by another PDP context already in use, the module could receive an ERROR message after the sending of the PDN Connectivity Request.



The #DUALAPN=0 mode does not allow to the commands #SGACT, +CGACT, ATD, NCM, and NBIM to use simultaneously two different <cid> having the same APN and PDP type. Only one command at a time can work with a <cid> that uses an APN and a PDP type used also by other cid. See warning note in chapter 5.3

To have information on command syntax and parameters values refer to document [4].

5.8.1.2. Examples on #DUALAPN=0 Mode

5.8.1.2.1. Defined APN

At power on, assume that the PDP context identified by <cid>=1 uses "IP" and "Access_Point_Name", as shown below.

AT+CGDCONT?

```
+CGDCONT: 1,"IP","Access_Point_Name","",0,0
OK
```

Check if the module is registered on a 4G network.

AT+COPS?

```
+COPS: 0,0,"Network_Operator",7          7 ← E-UTRAN
OK
```

Check if the Default EPS Bearer is active

AT+CGCONTRDP=?

```
+CGCONTRDP: {1}
OK
```

Check the #DUALAPN mode.

AT#DUALAPN?

```
#DUALAPN: 0,0,0          ← 0 mode, default configuration
OK
```

If you assign to <cid>=2 the same APN and PDP type already in use with <cid>=1, the <cid>=2 is routed to the <cid>=1, according to #DUALAPN=0 mode (default). Therefore, the IP address of both <cid> will be the same, see the following AT commands sequence.

AT+CGDCONT=2,"IP","Access_Point_Name"

OK

AT+CGDCONT?

```
+CGDCONT: 1,"IP","Access_Point_Name","",0,0
+CGDCONT: 2,"IP","Access_Point_Name","",0,0
OK
```

Now, only the first context is active.

AT+CGPADDR=

```
+CGPADDR: 1,"2.192.16.194"
+CGPADDR: 2,""
OK
```

Activate the second context.

AT#SGACT=2,1



```
#SGACT: 2.192.16.194
OK
```

The command returns the error code identifying the network reject cause. If no error, the code is 0.

```
AT#CEERNET
#CEERNET: 0
OK
```

As stated before, both <cid> have the same IP address.

```
AT+CGPADDR=
+CGPADDR: 1,"2.192.16.194"
+CGPADDR: 2,"2.192.16.194"
OK
```

5.8.1.2.2. Not Defined APN

At power on, assume that the PDP context identified by <cid>=1 uses a not defined APN, and a group of PDP contexts use the same APN and same PDP type as shown by the following command.

Check the current PDP contexts setting.

```
AT+CGDCONT?
+CGDCONT: 1,"IPV4V6","", "",0,0
+CGDCONT: 2,"IP","Access_Point_Name","0.0.0.0",0,0
+CGDCONT: 9,"IP","Access_Point_Name","0.0.0.0",0,0
+CGDCONT: 13,"IP","Access_Point_Name","0.0.0.0",0,0
+CGDCONT: 15,"IP","Access_Point_Name","0.0.0.0",0,0
OK
```

At power on, the context identifier <cid>=1 is automatically associated to the Default EPS Bearer assigned by the Network Operator in response of the not defined APN (see +CGDCONT? command).

```
AT+CGCONTRDP=1
+CGCONTRDP:
1,
5,
"APN_Assigned_by_Network",
"10.178.59.124.255.0.0.0",
"10.178.59.125",
"213.230.129.10",
"0.0.0.0","0.0.0.0",
```

"0.0.0.0"
OK

Check the current binding between sockets and PDP contexts.

AT#SCFG?

#SCFG: 1,1,300,90,600,50

#SCFG: 2,9,300,90,600,50

#SCFG: 3,1,300,90,600,50

#SCFG: 4,2,300,90,600,50

#SCFG: 5,13,300,90,600,50

#SCFG: 6,15,300,90,600,50

OK

Check the #DUALAPN mode.

AT#DUALAPN?

#DUALAPN: 0,0,0,0 ← 0 mode, default configuration

OK

Check which are the PDP contexts active.

AT#SGACT?

#SGACT: 1,0

#SGACT: 2,0

#SGACT: 9,0

#SGACT: 13,0

#SGACT: 15,0

OK

Activate PDP context <cid>=2.

AT#SGACT=2,1

#SGACT: 2.192.8.164

OK

Activate PDP context <cid>=9.

AT#SGACT=9,1

#SGACT: 2.192.8.164

OK

Activate PDP context <cid>=13.

AT#SGACT=13,1

#SGACT: 2.192.8.164

OK

Activate PDP context <cid>=15.

AT#SGACT=15,1



```
#SGACT: 2.192.8.164
OK
```

```
AT+CGPADDR=
```

```
+CGPADDR: 1,"10.178.59.124"
+CGPADDR: 2,"2.192.8.164"
+CGPADDR: 9,"2.192.8.164"
+CGPADDR: 13,"2.192.8.164"
+CGPADDR: 15,"2.192.8.164"
OK
```

PDP contexts 2, 9, 13, 15 are using the same IP address, according to the #DUALAPN=0 mode.

5.8.1.3. Examples on #DUALAPN=1 Mode

5.8.1.3.1. Defined APN

At power on, assume that the PDP context identified by <cid>=1 uses "IP" and "Access_Point_Name", as shown below.

```
AT+CGDCONT?
```

```
+CGDCONT: 1,"IP","Access_Point_Name","",0,0
OK
```

Check if the module is registered on a 4G network.

```
AT+COPS?
```

```
+COPS: 0,0,"Network_Operator",7 ← 7 = E-UTRAN
OK
```

Check if the Default EPS Bearer is active

```
AT+CGCONTRDP=?
```

```
+CGCONTRDP: {1}
OK
```

Set #DUALAPN=1 mode.

```
AT#DUALAPN=1
```

```
OK
```

Assigns to <cid>=2 the APN and PDP type associated to <cid>=1 already in use.

```
AT+CGDCONT=2,"IP","Access_Point_Name"
```

```
OK
```

AT+CGDCONT?

```
+CGDCONT: 1,"IP","Access_Point_Name","",0,0
+CGDCONT: 2,"IP","Access_Point_Name","",0,0
OK
```

Only the first context is active.

AT+CGPADDR=

```
+CGPADDR: 1,"2.192.16.194"
+CGPADDR: 2,""
OK
```

Enable error report in verbose format.

AT+CMEE=2

```
OK
```

Activate the context <cid>=2. When a PDN Connectivity Request is sent, the command returns an ERROR.

AT#SGACT=2,1

```
+CME ERROR: activation failed
```

The command returns the error code identifying the network reject cause.

AT#CEERNET

```
#CEERNET: 55
OK
```

AT+CGPADDR=

```
+CGPADDR: 1,"2.192.16.194"
+CGPADDR: 2,""
OK
```

5.8.1.3.2. Not Defined APN

At power on, assume that the PDP context identified by <cid>=1 uses a not defined APN.

Enable error report in verbose format.

AT+CMEE=2

```
OK
```

Set #DUALAPN=1 mode.

AT#DUALAPN=1

```
OK
```

Check the current user defined PDP contexts.

AT+CGDCONT?

```
+CGDCONT: 1,"IPV4V6","","",0,0
+CGDCONT: 2,"IP","Access_Point_Name","0.0.0.0",0,0
+CGDCONT: 9,"IP","Access_Point_Name","0.0.0.0",0,0
+CGDCONT: 13,"IP","Access_Point_Name","0.0.0.0",0,0
+CGDCONT: 15,"IP","Access_Point_Name","0.0.0.0",0,0
OK
```

The context identifier <cid>=1 is automatically associated to the Default EPS Bearer assigned by the Network Operator in response of the not defined APN (see +CGDCONT? command).

AT+CGCONTRDP=1

```
+CGCONTRDP:
1,
5,
"APN_Assigned_by_Network",
"10.178.47.1.255.0.0.0",
"10.178.59.125",
"213.230.129.10",
"0.0.0.0","0.0.0.0",
"0.0.0.0"
OK
```

Check the current binding between sockets and PDP contexts.

AT#SCFG?

```
#SCFG: 1,1,300,90,600,50
#SCFG: 2,9,300,90,600,50
#SCFG: 3,1,300,90,600,50
#SCFG: 4,2,300,90,600,50
#SCFG: 5,13,300,90,600,50
#SCFG: 6,15,300,90,600,50
OK
```

Activate PDP context <cid>=2.

AT#SGACT=2,1

```
#SGACT: 2.192.18.18
OK
```

Activate PDP context <cid>=9.

AT#SGACT=9,1

```
+CME ERROR: activation failed
```

The command returns the error code identifying the network reject cause.



```
AT#CEERNET
#CEERNET: 55
OK
```

Check which are the active PDP contexts. PDP context <cid>=1 is automatically activated during the attach procedure, but its right state is shown by the #SGACT command only if AT#SGACT=1,1 command is used, see the following AT commands sequence.

```
AT#SGACT?
#SGACT: 1,0
#SGACT: 2,1
#SGACT: 9,0
#SGACT: 13,0
#SGACT: 15,0
OK
```

```
AT#SGACT=1,1
#SGACT: 10.178.47.1
OK
```

```
AT#SGACT?
#SGACT: 1,1
#SGACT: 2,1
#SGACT: 9,0
#SGACT: 13,0
#SGACT: 15,0
OK
```

```
AT+CGPADDR=
+CGPADDR: 1,"10.178.47.1"
+CGPADDR: 2,"2.192.18.18"
+CGPADDR: 9,""
+CGPADDR: 13,""
+CGPADDR: 15,""
OK
```

```
AT+CGCONTRDP=2
+CGCONTRDP:
2,
6,
"Access_Point_Name.....",
"2.192.18.18.255.0.0.0",
"2.192.18.19",
"10.207.43.46",
```

```
"0.0.0.0",
"0.0.0.0",
"0.0.0.0"
OK
```

5.8.2. Platform Version ID 30, 37

For Platform Version ID 30 #DUALAPN command is supported in the modem.

For Platform Version ID 37 it is not possible to set different <cid> (AT+CGDCONT) with same APN and PDP type.

But if customization (AT#FWSWITCH) is such that on <cid>=1 empty APN is needed, after checking APN assigned by the network (AT+CGCONTRDP), it is possible to set the same APN on another <cid>=N.

Then, it is possible to “activate” <cid>=N with

AT#SGACT=N,1

and use the same IP address obtained during attach for <cid>=1.

5.8.2.1. Platform Version ID 30, 37 - Example

AT+CGCONTRDP=1

+CGCONTRDP:

1,

5,

"APN_Assigned_by_Network",

"10.178.47.1",

,

"192.168.100.43",

"192.168.100.44"

OK

AT+CGDCONT=2,"IP","APN_Assigned_by_Network"

OK

AT#SGACT=2,1 ← same IP address available for <cid>=1 and obtained during attach will be “activated”.

5.9. Authentication Setting, #PDPAUTH Command

5.9.1. Platform Version ID 20 and 25

The #PDPAUTH command specifies PDP authentication parameters values for a PDP context identified by the (local) context identifier <cid>. To get information on the command syntax and its parameters refer to documents [4] or [13] according to the module used.

AT#PDPAUTH=<cid>,<auth_type>,[< username>],[<password >]]

5.9.1.1. Modules: LE910 and, LE910Cx Series

Modules: LE910-EU1, B1-EU, -JN1, -NA1, B1-NA, B1-SA, -NA V2, B4-NA, -EU V2, AU V2 and LE910Cx SERIES

At power on, assume that the context identifier <cid>=1 is assigned to a not defined APN.

AT+CGDCONT?

+CGDCONT: 1,"IPV4V6","", "",0,0
OK

At power on, after the attach procedure, the context identifier <cid>=1 is automatically associated to the Default EPS Bearer assigned by the Network Operator in response of the not defined APN.

AT+CGCONTRDP=1

+CGCONTRDP:
1,
5,
"APN_Assigned_by_Network",
"100.80.28.204.255.0.0.0","100.80.28.205",
"80.201.237.239",
"0.0.0.0","0.0.0.0",
"0.0.0.0"
OK

Set up the new PDP Context associated to <cid>=1.

AT+CGDCONT=1,"IPV4V6","Access_Point_Name"

OK

Verify the entered PDP Context.

AT+CGDCONT?



```
+CGDCONT: 1,"IPV4V6","Access_Point_Name","",0,0  
OK
```

Set the PDP authentication parameters on context <cid>=1.

```
AT#PDPAUTH=1,1,"UserName","PassWord"  
OK
```

Detach the module from the network.

```
AT+CGATT=0  
OK
```

Attach the module to the network, the new PDP Context is activated. It is the new Default EPS Bearer.

```
AT+CGATT=1  
OK
```

Check the dynamic parameters of the PDP context assigned by the Network Operator in response of the user defined PDP context.

```
AT+CGCONTRDP=1  
+CGCONTRDP:  
1,  
5,  
"Access_Point_Name.....",  
"10.113.0.66.255.0.0.0",  
"10.113.0.67","8.8.4.4",  
"0.0.0.0","0.0.0.0",  
"0.0.0.0"  
OK
```

5.9.2. Platform Version ID 30, 37

The +CGAUTH command allows the module to specify authentication parameters for a PDP context identified by the (local) context identification parameter <cid>, used during the PDP context activation and the PDP context modification procedures.

To get information on the command syntax and its parameters refer to documents [14] or [15] according to the module used.

```
AT+CGAUTH=<cid>,<auth_type>,<username>,<password>
```

5.9.2.1. Platform Version ID 30, 37 - Example

Set the PDP authentication parameters on context <cid>=1.

```
AT+CGAUTH=1,1,"UserName","PassWord"
```

```
OK
```

Detach the module from the network.

```
AT+CGATT=0
```

```
OK
```

Attach the module to the network, the PDP Context is activated. It is the Default EPS Bearer.

```
AT+CGATT=1
```

```
OK
```

Check the dynamic parameters of the PDP context assigned by the Network Operator

```
AT+CGCONTRDP=1
```

```
+CGCONTRDP:
```

```
1,
```

```
5,
```

```
"Access_Point_Name.....",
```

```
"10.113.0.66.255.0.0.0",
```

```
"10.113.0.67","8.8.4.4",
```

```
"0.0.0.0","0.0.0.0",
```

```
"0.0.0.0"
```

```
OK
```

6. OUTGOING SOCKETS IN ONLINE MODE

6.1. Sockets Configuration, #SCFG Command

Use the #SCFG command to configure a socket belonging to the Multi-socket environment, the <connId> parameter identifies the socket. The Multi-socket environment provides N sockets, the N value depends on the module you are using. The configuration is saved in NVM, the command syntax is:

AT#SCFG = <connId>,<cid>,<pktSz>,<maxTo>,<connTo>,<txTo>

To get parameters descriptions refer to documents [1] or [2] for 2G or 3G modules, and [4], [11], [13], [14] or [15] for 4G modules.

6.1.1. 2G/3G Modules

Tab. 4 shows the default sockets/contexts binding returned by the AT#SCFG? read command. The socket configuration cannot be modified when the socket is open.

IP Easy Multi-Socket <connId>	<cid>=1	<cid>=2	<cid>=3	<cid>=4	<cid>=5
1	bound	/	/	/	/
2	bound	/	/	/	/
3	bound	/	/	/	/
4	/	bound	/	/	/
5	/	bound	/	/	/
6	/	bound	/	/	/

Tab. 4: 2G/3G Default Sockets/Contexts Binding Configuration

Example

Starting from the default configuration, bind the socket <connId>=2 to the PDP context <cid>=3.

AT#SCFG = 2, 3, 300, 90, 600, 50

OK

Check the new sockets/contexts binding.

AT#SCFG?

#SCFG: 1,1,300,90,600,50

#SCFG: 2,3,300,90,600,50

```
#SCFG: 3,1,300,90,600,50
#SCFG: 4,2,300,90,600,50
#SCFG: 5,2,300,90,600,50
#SCFG: 6,2,300,90,600,50
OK
```

Tab. 5 shows the new sockets/contexts binding configuration.

IP Easy Multi-Socket <connId>	<cid>=1	<cid>=2	<cid>=3	<cid>=4	<cid>=5
1	bound	/	/	/	/
2	bound	/	/	/	/
3	bound	/	/	/	/
4	/	bound	/	/	/
5	/	bound	/	/	/
6	/	bound	/	/	/

Tab. 5: 2G/3G Sockets/Contexts Binding Configuration

6.1.2. 4G Modules

6.1.2.1. Platform Version ID 20

6.1.2.1.1. Modules: LE910 Series

Modules: LE910-EU1, B1-EU, -JN1, -NA1, B1-NA, B1-SA, -NA V2, B4-NA, -EU V2, AU V2

Use the AT#SCFG? read command to get the current socket/cid configurations. The following is the default configuration.

AT#SCFG?

AT#SCFG?

```
#SCFG: 1,1,300,90,600,50
#SCFG: 2,1,300,90,600,50
#SCFG: 3,1,300,90,600,50
#SCFG: 4,2,300,90,600,50
#SCFG: 5,2,300,90,600,50
#SCFG: 6,2,300,90,600,50
#SCFG: 7,1,300,90,600,50
#SCFG: 8,1,300,90,600,50
```

```
#SCFG: 9,2,300,90,600,50
#SCFG: 10,2,300,90,600,50
OK
```

Use the AT#SCFG=? test command to get the range of the supported values. <cid> range is 0-15.

```
AT#SCFG=?
#SCFG: (1-10),(0-15),(0-1500),(0-65535),(10-1200),(0-264)
OK
```

Use the AT+CGDCONT=? test command to get the range of the supported values. <cid> range, identifying PDP contexts, is 1-15.

```
AT+CGDCONT=?
+CGDCONT: (1-15),"IP",,,0,(0-4),(0,1),(0,1),(0,1),(0,1)
+CGDCONT: (1-15),"IPV6",,,0,(0-4),(0,1),(0,1),(0,1),(0,1)
+CGDCONT: (1-15),"IPV4V6",,,0,(0-4),(0,1),(0,1),(0,1),(0,1)
OK
```

Use the AT+CGDCONT? read command to get the current PDP contexts configurations. The following is the default configuration.

```
AT+CGDCONT?
+CGDCONT: 1,"IPV4V6",,"",0,0
OK
```

Tab. 6 summarizes how <cid> and sockets can be used.

Sockets	<cid>=1	<cid>=2	<cid>=3	<cid>=4	<cid>=5 - 15
Internal Sockets (not directly accessible to the user)	During the attach procedure, the network assigns to the module the Default EPS Bearer that supports the service provided by the used Network Operator. By default, is used <cid>=1 bound to an internal socket. See chapter 5.1.				
IP Easy Multi-Socket <connId>	The user can bind all <cid> to sockets belonging to the Multi-socket environment, at the same time.				
1 - 10					

Tab. 6: LE910-EU1, Network Operator Service & Multi-Socket

6.1.2.1.2. Modules: LE910-SV1, -SVL, SV V2

Use the AT#SCFG? read command to get the current socket/cid configurations. The following is the default configuration.

AT#SCFG?

AT#SCFG?

```
#SCFG: 1,3,300,90,600,50
#SCFG: 2,3,300,90,600,50
#SCFG: 3,3,300,90,600,50
#SCFG: 4,2,300,90,600,50
#SCFG: 5,2,300,90,600,50
#SCFG: 6,2,300,90,600,50
#SCFG: 7,3,300,90,600,50
#SCFG: 8,3,300,90,600,50
#SCFG: 9,3,300,90,600,50
#SCFG: 10,3,300,90,600,50
OK
```

Use the AT#SCFG=? test command to get the range of the supported values. <cid> range is 0-15

AT#SCFG=?

```
#SCFG: (1-10),(0-15),(0-1500),(0-65535),(10-1200),(0-264)
OK
```

Use the AT+CGDCONT=? test command to get the range of the supported values. <cid> range is 1-6.

AT+CGDCONT=?

```
+CGDCONT: (1-6),"IP" ,,,0,(0-4),(0,1),(0,1),(0,1),(0,1)
+CGDCONT: (1-6),"IPV6" ,,,0,(0-4),(0,1),(0,1),(0,1),(0,1)
+CGDCONT: (1-6),"IPV4V6" ,,,0,(0-4),(0,1),(0,1),(0,1),(0,1)
OK
```

Use the AT+CGDCONT? read command to get the current PDN contexts configurations. The following is the default configuration.

AT+CGDCONT?

```
+CGDCONT: 1,"IPV4V6","vzwims",,,,,0,0      Service: IMS
+CGDCONT: 2,"IPV4V6","vzadmin",,,,,0,0      Service: ADMIN
+CGDCONT: 3,"IPV4V6","vzwinternet",,,,,0,0  Service: INTERNET
+CGDCONT: 4,"IPV4V6","vzwapp",,,,,0,0      Unused
+CGDCONT: 5,"IPV4V6","vzw800",,,,,0,0      Unused
+CGDCONT: 6,"IPV4V6","vzwclass6",,,,,0,0    Service: INTERNET
OK
```

Tab. 7 summarizes how <cid> and sockets can be used.

Sockets	<cid>=1	<cid>=2	<cid>=3	<cid>=4/5	<cid>=6	<cid>=7 - 15
Internal Sockets (not directly accessible to the user)	By default, <cid>=1 is used for IMS Service assigned by the Network Operator and is bound to an internal socket.	By default, <cid>=2 is used for ADMIN Service assigned by the Network Operator and is bound to an internal socket.	By default, <cid>=3 is used for INTERNET Service assigned by the Network Operator and is bound to an internal socket.	Unused	By default, <cid>=6 is used for INTERNET Service assigned by the Network Operator and is bound to an internal socket.	
IP Easy Multi-Socket <connId>	The user can bind all <cid> to sockets belonging to the Multi-socket environment, at the same time.					
1 - 10						

Tab. 7: LE910-SV1, IMS, ADMIN, INTERNET Services & Multi-Socket

6.1.2.2. Platform Version ID 23

6.1.2.2.1. Modules: LE866-SV1, ME866A1-NV

Use the AT#SCFG? read command to get the current socket/cid configurations. The following is the default configuration.

```
AT#SCFG?
#SCFG: 1,3,300,90,600,50
#SCFG: 2,3,300,90,600,50
#SCFG: 3,3,300,90,600,50
#SCFG: 4,2,300,90,600,50
#SCFG: 5,2,300,90,600,50
#SCFG: 6,2,300,90,600,50
OK
```

Use the AT#SCFG=? test command to get the range of the supported values. <cid> range is 1-4.

```
AT#SCFG=?
#SCFG: (1-6),(1-4),(0-1500),(0-65535),(10-1200),(0-264)
OK
```

Use the AT+CGDCONT=? test command to get the range of the supported values. <cid> range is 1-4.

AT+CGDCONT=?

```
+CGDCONT: (1-4),"IP",,,0,(0-4),(0,1),(0,1),(0,1),(0,1)
+CGDCONT: (1-4),"IPV6",,,0,(0-4),(0,1),(0,1),(0,1),(0,1)
+CGDCONT: (1-4),"IPV4V6",,,0,(0-4),(0,1),(0,1),(0,1),(0,1)
OK
```

Use the AT+CGDCONT? read command to get the current PDN connections configuration. The following is the default configuration.

AT+CGDCONT?

```
+CGDCONT: 1,"IPV4V6","vzwims",,,,0,0,0,0,1,0 Service: IMS
+CGDCONT: 2,"IPV4V6","vzwapmin",,,,0,0 Service: ADMIN
+CGDCONT: 3,"IPV4V6","vzwinternet",,,,0,0 Service: INTERNET
OK
```

Tab. 8 summarizes how <cid> and sockets can be used.

Sockets	<cid>=1	<cid>=2	<cid>=3	<cid>=4
Internal Sockets (not directly accessible to the user)	By default, <cid>=1 is used for IMS Service assigned by the Network Operator and is bound to an internal socket.	By default, <cid>=2 is used for ADMIN Service assigned by the Network Operator and is bound to an internal socket.	By default, <cid>=3 is used for INTERNET Service assigned by the Network Operator and is bound to an internal socket.	
IP Easy Multi-Socket <connId>	The user can bind all <cid> to sockets belonging to the Multi-socket environment, at the same time.			
1 - 6				

Tab. 8: LE866-SV1, IMS, ADMIN, INTERNET Services & Multi-Socket

6.1.2.3. Platform Version ID 30, 37

Use the AT#SCFG? read command to get the current socket/cid configurations. The following is an example of configuration.

AT#SCFG?

```
#SCFG: 1,1,300,90,600,50
#SCFG: 2,1,300,90,600,50
#SCFG: 3,1,300,90,600,50
#SCFG: 4,1,300,90,600,50
#SCFG: 5,1,300,90,600,50
#SCFG: 6,1,300,90,600,50
#SCFG: 7,1,300,90,600,50
```

#SCFG: 8,1,300,90,600,50
 #SCFG: 9,1,300,90,600,50
 #SCFG: 10,1,300,90,600,50

Use the AT#SCFG=? test command to get the range of the supported values. <cid> range is 0-15

AT#SCFG=?

#SCFG: (1-10),(0-15),(0-1500),(0-65535),(10-1200),(0-264)

OK

To have detailed information about the #SCFG parameters refer to user guide [14] and [15] in accordance with the module used.

Use the AT+CGDCONT=? test command to get the range of the supported values. <cid> range is 1-6.

Use the AT+CGDCONT? read command to get the current PDN contexts configurations.

To have detailed information about the +CGDCONT parameters refer to user guide [14] and [15] in accordance with the module used.

6.2. Open a Socket, #SD Command

The #SD command (Socket Dial) opens the TCP/UDP connection towards the host. If required, DNS query is done to resolve the IP address. To open the remote connection, the PDP context to which the <connId> is associated must be active, otherwise the command returns an ERROR message. The command syntax is for:

- 2G modules, 3G modules with platforms version ID 12 and 4G modules with platform version ID 23 and 25 (refer to document [1], [2], [4], [11], or [13] according to the module used):

AT#SD=<connId>,<txProt>,<rPort>,<IPAddr>[, <closureType> [,<IPort>[,<connMode>]]]

- 4G modules with platform version ID 30, 37 (refer to documents [14] or [13])

AT#SD=<connId>,<txProt>,<rPort>,<IPAddr>[,<closureType>[,<IPort>[,<connMode> [,<txTime>[,<userIpType>]]]]]

6.2.1. Example on Opening & Suspension, (2G/3G)

This example shows the opening and suspension of the connections <connId>=3, and 2. The table below shows the starting sockets/contexts configuration:

- PDP context <cid>=1, and 3 active
- Sockets <connId>=1, and 3 bound to <cid>=1 (default)
- Socket <connId>=2 bound to <cid>=3
- Sockets <connId>=4, 5, and 6 bound to <cid>=2 (default)

IP Easy Multi-Socket <connId>	<cid>=1	<cid>=2	<cid>=3	<cid>=4	<cid>=5
	Active	No active	Active	No active	No active
1	bound	/	/	/	/
2	/	/	bound	/	/
3	bound	/	/	/	/
4	/	bound	/	/	/
5	/	bound	/	/	/
6	/	bound	/	/	/

Tab. 9: Sockets/Contexts Binding and PDPs Active

Open the connection in ONLINE mode.

AT#SD = 3,0,80,"Host_Name_1"

CONNECT

... data exchange ...

+++ ← suspend the connection.

OK ← connection 3 has been successfully suspended.

After the CONNECT message, the module is in ONLINE mode. Issue the escape sequence (+++) to suspend the connection and enter the COMMAND mode, the escape sequence does not close the connection.

If an escape sequence is included in the data to be sent, at the beginning of the sending, you must use the #SKIPESC command to guarantee that the connection is not suspended.

See the ATS12 command to set timing relevant to escape sequence. Set the guard time before and after escape sequence.

One more socket connection can be established.

AT#SD = 2, 0, 80,"Host_Name_2"

CONNECT

... data exchange ...

+++ ← suspend the connection.

OK ← connection 2 has been successfully suspended.

The module is again in COMMAND mode.

If a suspended connection receives data, the DTE displays an unsolicited SRING: <connId> indication. The unsolicited SRING indication appears only in COMMAND mode. For example, if Host_Name_1 sends data, the DTE displays the following URC:

SRING: 3 ← 3 is the number of the <connId> with pending data.

The table below shows the sockets/contexts configuration after the execution of the #SD commands.

- PDP context <cid>=1, and 3 active
- Sockets <connId>= 4, 5, and 6 bound to <cid>=2
- Socket <connId>=1 bound to <cid>=1
- Socket <connId>=2, bound to <cid>=3, and open
- Socket <connId>=3, bound to <cid>=1, and open

IP Easy Multi-Socket <connId>	<cid>=1	<cid>=2	<cid>=3	<cid>=4	<cid>=5
	Active	No active	Active	No active	No active
1	bound	/	/	/	/
2	/	/	open	/	/
3	open	/	/	/	/
4	/	bound	/	/	/
5	/	bound	/	/	/
6	/	bound	/	/	/

Tab. 10: Sockets/Contexts Binding and Sockets Opened

6.3. Pending Data, #PADCMD, #PADFWD Commands

The following two AT commands enable the flushing of the pending data on the local socket toward the remote side.

AT#PADCMD=1

OK

Set the ASCII code of the character that will trigger the flushing of the pending data. In this example is "A" = 65 (decimal value).

```
AT#PADFWD=65
```

```
OK
```

Open the connection.

```
AT#SD = 3, 0, 80, "Host Name 1"
```

```
CONNECT
```

```
.....
```

The data, pending on the socket, are sent to the remote side when one of the three conditions is verified:

- data size reaches <pktSz> (see #SCFG command), or
- <txTo> timeout is over (see #SCFG command), or
- also "A" character (used in this example) is sent to the remote side.

```
.....
```

```
.....
```

To get parameters descriptions refer to documents [1] or [2] for 2G or 3G modules, and [4], [11], [13], [14] or [15] for 4G modules.

6.4. Resume a Connection, #SO Command

Use #SO command to resume a suspended connection. The command syntax is:

```
AT#SO= <connId>
```

To get parameters descriptions refer to documents [1] or [2] for 2G or 3G modules, and [4], [11], [13], [14] or [15] for 4G modules.

Example

```
AT#SD = 2,0,80,"Host_Name"
```

```
CONNECT ← the connection is open.
```

```
... data exchange ...
```

```
+++ ← suspend the connection.
```

```
OK ← the module is in COMMAND mode.
```

Data are pending on socket.
SRING: 2

Resume the suspended connection.

AT#SO = 2
CONNECT

... pending data are displayed ...

.....
.....

+++ ← suspend the connection.

OK

You can resume a suspended connection without waiting for SRING unsolicited indication. In this case, the module returns the CONNECT message. If the connection is not open the returned message is NO CARRIER.

6.5. Close a Connection, #SH, #SLASTCLOSURE Commands

Use #SH command to close a socket connection. The command returns the OK message if the connection is already closed. The command syntax is:

AT#SH= <connId>

To get parameters descriptions refer to documents [1] or [2] for 2G or 3G modules, and [4], [11], [13], [14] or [15] for 4G modules.

Example

Open a socket connection.

AT#SD = 2,0,80,"Host_Name"
CONNECT ← the connection is open

... data exchange ...

+++ ← suspend the connection.

OK ← the module is in COMMAND mode

Type in #SH command to close the socket connection.

AT#SH = 2

OK

← the connection is closed.

A connection can be closed by the following events:

- Remote host closes the connection.
- Socket inactivity timeout is expired.
- DTE issues the escape sequence and #SH command.
- Network deactivates the connection.

Use #SLASTCLOSURE command to get the socket disconnection cause.

AT#SLASTCLOSURE=[<connId>]

#SLASTCLOSURE: <connId>,<cause> ← response format.

To get parameters descriptions, refer to documents [1], [2], [4], [11], or [13] according to the used module.

6.6. TCP/IP Options Configuration

6.6.1. Reassemble TCP Packets, #TCPREASS Command (2G)

Use #TCPREASS command to enable the reassembling of the fragmented TCP packets. The command syntax is:

AT#TCPREASS=<n>

Refer to document [1] to get parameters descriptions.

6.6.2. Max TCP Payload Size, #TCPMAXDAT Command (2G)

Use #TCPMAXDAT command to configure the maximum TCP/IP payload size accepted in one single TCP/IP datagram from the module. The <size> is sent by the module to the peer when the socket connection is opened.

AT#TCPMAXDAT=<size>

Refer to document [1] to get parameters descriptions. Here is an example:

The module advices the peer that it does not accept TCP/IP datagrams with a payload longer than 1000 bytes.

AT#TCPMAXDAT=1000

OK

6.6.3. #BASE64 Command

The #BASE64 command enables base64 encoding/decoding of data sent/received on a socket. The command syntax is:

AT#BASE64=<connId>,<enc>,<dec>[,<unused_B >[,<unused_C >]]

To get parameters descriptions refer to documents [1] or [2] for 2G or 3G modules, and [4], [11], [13], [14] or [15] for 4G modules.



#BASE64 command is not supported by Platform Version ID 23.

Example

Skip the escape sequence, its transmission is not enabled.

AT#SKIPESC=1
OK

Open the connection.

AT#SD=1,0,<Remote Host Port>,"IP Address"
CONNECT

... data exchange ...

+++ ← suspend the connection.

OK ← the module is in COMMAND mode

Encode all data coming from serial port and sent to the socket.

AT#BASE64=1,1,0
OK

Resume the connection.

AT#SO=1
CONNECT

.....
... data received from serial port are base64 encoded and sent to the socket. ...
.....



+++ ← suspend the connection.

OK ← the module is in COMMAND mode

Decode all data coming from the socket and sent to the serial line.

AT#BASE64=1,0,1

OK

Resume the connection.

AT#SO=1

CONNECT

.....

... data received from socket are base64 decoded and sent to the serial port. ...

.....

+++ ← suspend the connection.

OK ← the module is in COMMAND mode

7. INCOMING SOCKETS IN ONLINE MODE

Use the #SL (Socket Listening) command to open a socket in listening mode for an incoming TCP connection.

- You can configure up to N sockets in listening mode. The N value depends on the module you are using.
- Two sockets in listening mode cannot bound to the same PDP context (same IP address) and using the same port. To use the same port, the two sockets must be bound to two different PDP contexts (different IP addresses), refer to table below.

When a remote host tries to connect, the module sends to the DTE the +SRING: <connId> unsolicited indication. The user can accept (#SA) or refuse (#SH) the incoming connection. The command syntax is for:

- 2G modules, 3G modules (ID 12) and 4G modules (ID 20, 23). Refer to document [1], [2], [4], or [11] according to the module used.

AT#SL= <connId>,<listenState>,<listenPort>[,<closureType>]

- 4G modules (ID 25, 30, 37). Refer to documents [13], [14] or [13] according to the module used.

AT#SL=<connId>,<listenState>,<listenPort>[,<lingerT>]

IP Easy Multi-Socket <connId>	<cid>=1	<cid>=2	<cid>=3	<cid>=4	<cid>=5
	Active	No active	No active	Active	No active
1	listen, port_1	/	/	/	/
2	/	/	bound	/	/
3	listen, port_2	/	/	/	/
4	bound	/	/	/	/
5	/	/	/	listen, port_2	/
6	/	bound	/	/	/

Tab. 11: An Example of Sockets in Listening Mode

Example

Open the <connId> = 2 socket in listening mode on <port> = 6543.

AT#SL = 2,1,6543

OK

Now, if a remote host is trying to connect, the module receives a SRING unsolicited indication with the listening <connId>:

SRING: 2



If the incoming connection request is rejected, the listening socket will be closed. Use #SL command to reopen the socket.

7.1. Accept an Incoming Connection, #SA Command

Use the #SA command without <connMode> parameter to accept the incoming connection, notified by the SRING unsolicited indication, in ONLINE mode. The command syntax is:

AT#SA=<connId>[,<connMode>]

To get parameters descriptions refer to documents [1], [2], [4], [11], [13], [14] or [15] according to the module used.

Example

Open the socket connection <connId> = 3 in listening mode (only for TCP) on <ListenPort> = xxxx.

AT#SL = 3, 1, xxxx

OK

Now, if a remote host tries to connect, the module receives a SRING unsolicited indication with the listening <connId>:

SRING: 3 ← a remote host is trying to connect.

Accept the incoming connection <connId>=3 in ONLINE mode.

AT#SA = 3

CONNECT ← the connection is accepted.

... exchange data ...

The module is in ONLINE mode, the connection is established, and the two hosts can exchange data. With the escape sequence (+++) the connection can be suspended, and the module is back to COMMAND mode. Use #SO command to resume the suspended connection, refer to chapter 6.4.

To accept automatically incoming connection use #SCFGEXT command, refer to chapter 8.3.1.

7.2. Check the Socket State, #SS Command

Use the #SS command to get the current socket state. The command syntax is:

AT#SS[=<connId>]

Here is the response message format of the command.

#SS: <connId>,<state>,<locIP>,<locPort>,<remIP>,<remPort>

To get parameters descriptions, refer to documents [1], [2], [4], [13], [14] or [15] according to the module used.

Example

Check the state of all available sockets. In this case, the <connId> parameter is not used.

AT#SS

```
#SS: 1,4,217.201.131.110,21
#SS: 2,2,217.201.131.110,1033,194.185.15.73,10510
#SS: 3,3,217.201.131.110,1034,194.185.15.73,10510
#SS: 4,1,217.201.131.110,1035,194.185.15.73,10510
#SS: 5,0
#SS: 6,0
OK
```

By issuing AT#SS=<connId> the command returns only the state of the <connId> socket.

7.3. Open UDP Connection, #SLUDP Command

Use #SLUDP command to open a socket listening for an incoming UDP connection on a specified port. The command syntax is:

AT#SLUDP=<connId>, <listenState>, <listenPort>

To get parameters descriptions, refer to documents [1], [2], [4], [13], [14] or [15] according to the module used.

It is possible to receive SRING unsolicited and decide to accept (#SA) or refuse (#SH) the connection. To accept automatically incoming connection use #SCFGEXT command, refer to chapter 8.3.1

7.4. Firewall Setting, #FRWL Command

2G/3G/4G modules provide an internal firewall that controls the access of the incoming connections. DROP is the firewall policy, all packets not matching the rules are silently discarded. The firewall applies for incoming (listening) connections. Outgoing connections are established regardless of the firewall settings. Use the #FRWL command to add or remove an ACCEPT chain to/from internal firewall. The command syntax is:

AT#FRWL[=<action>,<ip_address>,<net mask>]

When a packet comes in from the <incoming IP> address, the firewall rules chain is scanned to match the following criteria:

<incoming IP> & <net mask> = <ip_address> & <net mask>

If matching is found, the packet is accepted and the rule scan is finished, otherwise the next chain is considered until the end of the rules. If no matching is found the packet is silently dropped.



#FRWL command is not enabled by default.

To get command syntax detail and parameters ranges, refer to documents [1], [2], [4], [13], [14] or [15] according to the module used.

Example

Assume to accept connections only from devices having the IP addresses ranging from 197.158.1.1 to 197.158.255.255. The following ACCEPT chain must be added to the firewall.

```
AT#FRWL=1,"197.158.1.1","255.255.0.0"  
OK
```

7.5. Examples

7.5.1. Modules in Server and Client Configurations

This example describes a remote connection between two modules. The first one is configured as a server. It opens a socket connection in listen mode (#SL). The second one is configured as a client, opens a socket dial connection (#SD) toward the server. Each module is connected to a terminal emulator. See also the example described in chapter 14.3.6, just for comparison.

Server side

Check the sockets/PDP contexts binding configuration (default configuration).

AT#SCFG?

#SCFG: 1,1,300,90,600,50

#SCFG: 2,1,300,90,600,50

#SCFG: 3,1,300,90,600,50

#SCFG: 4,2,300,90,600,50

#SCFG: 5,2,300,90,600,50

#SCFG: 6,2,300,90,600,50

OK

Assume that only PDP context <cid>=1 has been set, all other contexts have been removed.

AT+CGDCONT?

+CGDCONT: 1,"IP","Access_Point_Nam ","0.0.0.0",0,0

OK

Activate the PDP context <cid>=1. The command returns the IP address assigned by the network to the module. Assume that no UserID and Password are needed.

AT#SGACT=1,1

#SGACT: 2.192.9.179

OK

The client to open the connection will use this IP address, see client side.

Define an ACCEPT firewall chain to accept the IP address of the client; see client side.

AT#FRWL=1,"37.176.239.214","0.0.0.0"

OK

Open <connId>=1 socket in listening mode on <port>=1024. The client will use it.

AT#SL=1,1,1024

OK

When the client opens the connection, the server displays on the terminal emulator a SRING unsolicited indication with <connId>=1:

SRING: 1

Accept the connection 1.

AT#SA=1

CONNECT

... exchange data ...

NO CARRIER ← on the client side has been entered #SH command, the connection is closed.

Client side

Check the sockets/PDP contexts binding configuration (default configuration).

AT#SCFG?

#SCFG: 1,1,300,90,600,50

#SCFG: 2,1,300,90,600,50

#SCFG: 3,1,300,90,600,50

#SCFG: 4,2,300,90,600,50

#SCFG: 5,2,300,90,600,50

#SCFG: 6,2,300,90,600,50

OK

Assume that only PDP context <cid>=1 has been set, all other contexts have been removed.

AT+CGDCONT?

+CGDCONT: 1,"IP","Access_Point_Nam ","0.0.0.0",0,0

OK

Activate the PDP Context <cid>=1, assume that no UserID and Password are needed. The command returns the IP address assigned by the network to the module.

AT#SGACT=1,1

#SGACT: 37.176.239.214

OK

The server will use this IP address to set the firewall, see server side.

Open the connection toward the server using its IP address and port 1024, see sever side.

AT#SD=1,0,1024," 2.192.9.179"

CONNECT

... exchange data ...

+++ ← suspend the connection.

OK ← the module is in COMMAND mode

AT#SH=1 ← close the connection. On server side is displayed the NO CARRIER message.

OK

Use #CGPADDR= command to verify the IP address assigned by the network to the modules after the PDP contexts activations; refer to chapter 4.4.

8. SOCKET CONNECTION IN COMMAND MODE

The #SD (Socket Dial) and #SA (Accept connection) commands are introduced respectively in chapter 6.2 and 7.1, and their descriptions are focused on the ONLINE mode connection. In this case, the optional parameter <connMode> is set to 0 (default).

The present section describes the use of the two commands with the parameter <connMode> set to 1. The #SD command with <connMode> set to 1 opens a connection, leaves the module in COMMAND mode, and allows the user to enter AT commands even when the socket connection is open. If data are received on the connection, a SRING unsolicited message is displayed on DTE.

8.1. Open a Socket, #SD Command

Use #SD command with <connMode>=1 to open a connection in COMMAND mode.

The command syntax is for:

- 2G modules, 3G modules with platforms version ID 12 and 4G modules with platform version ID 23 and 25 (refer to document [1], [2], [4], [11], or [13] according to the module used):

AT#SD=<connId>,<txProt>,<rPort>,<IPAddr>,<closure type>,<lPort>,[1]]]

- 4G modules with platform version ID 30, 37 (refer to documents [14] or [13] according to the module used):

AT#SD=<connId>,<txProt>,<rPort>,<IPAddr>,<closureType>,<lPort>,[1,<txTime>,<userIpType>]]]]]

8.2. Accept an Incoming Connection, #SA Command

Use #SA command with <connMode>=1 to accept the connection in COMMAND mode. <connMode> is the last parameter in the syntax command.

AT#SA = <connId>,[1]

Here is the unsolicited indication notifying the user that pending data are available on <connId> connection. For examples, refer to chapter 8.7.

SRING: <connId>.

8.3. Extended Socket Parameters Configuration

8.3.1. #SCFGEXT Command

#SCFGEXT command configures the set of the extended parameters for each socket provided by the Multi-socket environment; the values are saved in NVM. The command syntax is:

```
AT#SCFGEXT=<connId>,<srMode>,<recvDataMode>,<keepalive>[,<ListenAutoRsp>[,<sendDataMode>] ]
```

To get parameters descriptions of the commands described in the following chapters, refer to documents [1], [2], [4], [11], [13], [14] or [15] according to the module used.

Here is the <srMode> range. For examples, refer to chapter 8.7.

- 0 – Normal (default)
- 1 – Data amount
- 2 – Data view
- 3 – Data view with UDP datagram information

Example

Use the test command to get the range of the supported values. Pay attention to: <connId> range: 1-6, <srMode> range: 0-3.

```
AT#SCFGEXT=?
#SCFGEXT: (1-6),(0-3),(0,1),(0-240),(0,1),(0,1)
OK
```

Use the read command to get the current socket extended configuration.

```
AT#SCFGEXT?
#SCFGEXT: 1,0,0,0,0,0
#SCFGEXT: 2,0,0,0,0,0
#SCFGEXT: 3,0,0,0,0,0
#SCFGEXT: 4,0,0,0,0,0
#SCFGEXT: 5,0,0,0,0,0
#SCFGEXT: 6,0,0,0,0,0
OK
```

Set SRING Data amount mode on socket 1

```
AT#SCFGEXT = 1,1,0,0
OK
```

Set SRING Data view mode on socket 2



```
AT#SCFGEXT = 2,2,1,0,0,1
OK
```

```
Set SRING Data view UDP info mode on socket 6
AT#SCFGEXT = 6,3,1,0
OK
```

Check the current socket extended configuration.

```
AT#SCFGEXT?
#SCFGEXT: 1,1,0,0,0,0
#SCFGEXT: 2,2,1,0,0,1
#SCFGEXT: 3,0,0,0,0,0
#SCFGEXT: 4,0,0,0,0,0
#SCFGEXT: 5,0,0,0,0,0
#SCFGEXT: 6,3,1,0,0,0
OK
```

8.3.2. #SCFGEXT2 Command

Use the # SCFGEXT2 command to configure additional extended parameters. Here is the command syntax for each module technology.

8.3.2.1. 2G modules

```
AT#SCFGEXT2=<connId>,<bufferStart>[,<abortConnAttempt>
                [,<sringLen >[,<sringTo >[,<noCarrierMode>]]]]
```

Refer to documents [1].

8.3.2.2. 3G/4G modules

```
AT#SCFGEXT2=<connId>,<bufferStart>[,<abortConnAttempt>
                [,<unused_B >[,<unused_C >[,< noCarrierMode >]]]]
```

To get more information, refer to documents [2], [4], [13], [14] or [15] according to the module used.

8.4. Send Data, #SEND and #SENDEXT Commands

Use #SEND command to send data on a connection when the module is in COMMAND mode. When the <CR> is entered to close the entering of the command, the ">" prompt appears to indicate that the command is ready to accept the data to be sent. Enter Ctrl-Z to close the data entering and send the data. Before using the command, the socket must be opened. The command syntax is:

AT#SEND=<connId>

Use #SENDEXT command to include all bytes (0x00 to 0xFF) in the block of data to send. This command allows to include special characters as ESC (0x1B), Ctrl-Z (0x1A), BS (0x08) not accepted by #SEND. The command syntax is:

AT#SENDEXT=<connId>,<bytestosend>

To get parameters descriptions, refer to documents [1], [2], [4], [11] or [13] according to the module used. For examples refer to chapter 8.7.

For platforms ID 30 and 37 the command syntax is:

AT#SEND=<connId>[,<Rai>]

AT#SENDEXT=<connId>,<bytestosend>[,<Rai>]

To get parameters descriptions, refer to documents [14] or [15] according to the module used.

8.5. Receive Data, #SRECV Command

The module is in COMMAND mode and assume to have received a SRING unsolicited indication notifying that received data are pending in the socket. Use #SRECV command to get the pending data in the socket buffer. The command syntax is:

AT#SRECV=<connId>,<maxByte>[,<UDPinfo>]

To get parameters descriptions, refer to documents [1], [2], [4], [13], [14] or [15] according to the module used.

For examples refer to chapter 8.7.

Example

Assume to have received a SRING Data amount unsolicited indication, see #SCFGEXT command.

SRING: 1,5

Extract all the five bytes.

AT#SRECV=1,5

#SRECV: 1,5

hello

← here are the five bytes, as example: hello.

OK

8.6. Socket Information, #SI Command

Use #SI command to get additional information on all sockets or on the selected socket. The command syntax is:

AT#SI[= <connId>]

The format of the command response is:

#SI: <connId>,<sent>,<received>,<buff_in>,<ack_waiting>

To get parameters descriptions, refer to documents [1], [2], [4], [13], [14] or [15] according to the module used.

Example

Get information on all the available sockets.

AT#SI

#SI: 1,123,400,10,50

#SI: 2,0,100,0,0

#SI: 3,589,100,10,100

#SI: 4,0,0,0,0

#SI: 5,0,0,0,0

#SI: 6,0,98,60,0

OK

8.7. Examples

8.7.1. Switching from COMMAND to ONLINE Mode and Back

Assume that the SRING unsolicited mode has been configured in Data amount mode through the #SCFGEXT command. The socket <connId>=1 has been configured, and the used PDP context has been configured and activated. Enable the error report in verbose format (+CMEE=2).

Use #SO command to switch from COMMAND to ONLINE mode, and +++ escape sequence to go back in COMMAND mode.

Open socket connection <connId>=1 in COMMAND mode on echo port.

```
AT#SD=1,0,echo_port,"address",0,0,1
```

```
OK ← the socket connection is open; the module is in COMMAND mode.
```

Send data on the socket. Text view mode for received data (#SCFGEXT).

```
AT#SEND=1
```

```
> helloCtrl-Z ← type in the first message.
```

```
OK
```

```
SRING: 1,5 ← SRING in Data amount mode, 1 is the connection Id, 5 is the amount of the echoed data (hello).
```

```
AT#SO = 1 ← resume the suspended connection.
```

```
CONNECT
```

```
hello ← echoed data pending on the socket are sent to the terminal emulator.
```

Now, the AT interface is in ONLINE mode. All the entered characters are interpreted as data to send on the connection. The remote side returns the sent message (echo).

```
+++ ← suspend the connection. The escape sequence is not displayed on the terminal emulator.
```

```
OK ← the module is in COMMAND mode.
```

```
SRING: 1,3 ← SRING in Data amount mode, 1 is the connection Id, 3 is the amount of echoed data (+++).
```

Now, close the socket connection.

```
AT#SH=1
```

```
OK
```

If the socket connection is not closed, its time out expires, and the NO CARRIER message is displayed on the terminal emulator.

8.7.2. Accept a Socket Connection in COMMAND Mode

Open the socket connection <connId> = 1 in listening mode (only for TCP) on <port> = xxxx.

```
AT#SL = 1,1,xxxx
```

```
OK
```

Now, if a remote host tries to connect, the module receives a SRING unsolicited indication with the listening <connId>=1.

```
SRING: 1
```

Accept the incoming connection in COMMAND mode.

```
AT#SA = 1,1
```

```
OK
```

← the connection is accepted. The command returns OK message if the connection is successful. The module stays in COMMAND mode. When <connMode>=0 (default) the #SA command returns the CONNET message, in this case the module is in ONLINE mode.

Check the sockets state.

```
AT#SS
```

```
#SS: 1,2,loc_ip,loc_port,rem_ip,rem_port ← <connId>=1 is open in suspended state.
```

```
#SS: 2,0
```

```
#SS: 3,0
```

```
#SS: 4,0
```

```
#SS: 5,0
```

```
#SS: 6,0
```

```
OK
```

8.7.3. SRING Unsolicited Mode: Normal

Assume that the SRING unsolicited mode has been configured in Normal mode through the #SCFGEXT command, the socket <connId>=2 has been configured, and the PDP context has been configured and activated. Enable the error report in verbose format (+CMEE=2).

Open socket connection <connId>=2 in COMMAND mode on echo port.

AT#SD=2,0,echo_port,"address",0,0,1

OK ← the socket connection is open; the module is in COMMAND mode.

Send data on the socket. Text view mode for received data (#SCFGEXT).

AT#SEND=2

> helloCtrl-Z ← type in the first message.

OK

SRING: 2 ← SRING in Normal mode, 2 is the socket connection Id. Only one SRING unsolicited indication is received, regardless if you must send other data.

AT#SEND=2

> helloCtrl-Z ← type the second message.

OK

...

Close the socket connection.

AT#SH=2

OK

8.7.4. SRING Unsolicited Mode: Data amount

Assume that the SRING unsolicited mode has been configured in Data amount mode through the #SCFGEXT command, the socket <connId>=2 has been configured, and the PDP context has been configured and activated. Enable the error report in verbose format (+CMEE=2).

Open socket connection <connId>=2 in COMMAND mode on echo port.

AT#SD=2,0,echo_port,"address",0,0,1

OK ← socket connection is open in COMMAND mode.

AT#SEND=2 ← send data.

> helloCtrl-Z ← type in the first message

OK

SRING: 2,5 ← SRING in Data amount mode, 2 is the connection Id, 5 is the amount of the echoed data.

AT#SEND=2

> helloCtrl-Z ← type the second message

OK

SRING: 2,10 ← SRING in Data amount mode, unsolicited indication is updated every time new data arrives on the socket.

AT#SI=2 ← get socket info.
#SI: 2,10,0,10,0 ← ten bytes sent, and ten pending on the socket.
OK

AT#SO = 2 ← resume the suspended socket connection.
CONNECT
hellohello ← data pending on the socket are sent to the terminal emulator.

Now, the AT interface is in ONLINE mode. All entered characters are interpreted as data to send on the connection. The remote side returns the sent message (echo).

+++ ← suspend the connection. The escape sequence is not displayed on the terminal emulator.
OK ← the module is in COMMAND mode.

SRING: 2,3 ← SRING in Data amount mode, 2 is the connection Id, 3 is the amount of echoed data (+++).

Now, close the socket connection.

AT#SH=2
OK

If the socket connection is not closed, its time out expires, and the NO CARRIER message is displayed on the terminal emulator.

8.7.5. SRING Unsolicited Mode: Data view

Assume that the SRING mode has been configured in Data view mode through the #SCFGEXT command, the sockets <connId>=1/2 have been configured, and the used PDP context has been configured and activated. Enable the error report in verbose format (+CMEE=2).

Configure socket <connId>=1 in Data view mode and set text view.

AT#SCFGEXT = 1,2,0,0
OK

Configure socket <connId>=2 in Data view mode and set hex view.

AT#SCFGEXT = 2,2,1,0
OK

Send data in hexadecimal format:

```
AT#SEND=1
> 68656C66FCtrl-Z
OK
```

SRING: 1,5,68656C66F ← receive data in hexadecimal format.

8.7.6. SRING Unsolicited Mode: Data view UDP

Assume that the SRING mode has been configured in Data view UDP mode through the #SCFGEXT command, the sockets <connId>=1/2 have been configured, and the used PDP context has been configured and activated. Enable the error report in verbose format (+CMEE=2).

Configure <connId>=1 in Data view mode with UDP info and set text view.

```
AT#SCFGEXT = 1,3,0,0
OK
```

Configure <connId>=2 in Data view mode and set hex view.

```
AT#SCFGEXT = 2,3,1,0
OK
```

Open the UDP connections <connId>=1 in COMMAND mode, on echo port.

```
AT#SD=1,1,echo_port,"address",0,0,1
OK ← the socket connection is open; the module is in COMMAND mode.
```

Open the UDP connections <connId>=2 in COMMAND mode, on echo port.

```
AT#SD=2,1,echo_port,"address",0,0,1
OK ← the socket connection is open; the module is in COMMAND mode.
```

Send data on the first socket, text mode:

```
AT#SEND=1
> helloCtrl-Z
OK
```

SRING: "address",echo_port,1,5,0,hello

Send data on the second socket, hex mode for received data:

```
AT#SEND=2
> helloCtrl-Z
```



OK

SRING: "address",echo_port,2,5,0,68656C6C6F

Send on socket <connId>=1 more than the maximum number of chars for a SRING, this will cause two unsolicited SRING.

AT#SEND=1

> testtesttesttesttesttesttesttesttesttesttesttesttesttesttesttesttestCtrl-Z

OK

SRING:

"address",echo_port,1,64,4,testtesttesttesttesttesttesttesttesttesttesttesttesttesttesttesttestst

SRING: "address",echo_port,1,4,0,test

The first unsolicited contains the first 64 bytes of the socket buffer, the remaining 4 are extracted with the second unsolicited message.

9. MULTI-SOCKET & PROTOCOL SERVICE SOCKETS

9.1. 2G/3G Modules

Referring to Tab. 12:

- Multi-socket (IP Easy environment):

Sockets identified by <connId>= 1, 2, 3, are bound to <cid>=1 (as example)

Sockets identified by <connId>= 4, 5, 6, are bound to <cid>=3 (as example)

- Protocol Service Sockets:

HTTP Service socket bound to <cid>=1 (by default), refer to chapter 10

FTP Service socket bound to <cid>=1 (mandatory), refer to chapter 12

SMTP Service socket bound to <cid>=1 (mandatory), refer to chapter 11

PING Service socket bound to <cid>=1 (mandatory), refer to chapter 14

SSL Service socket bound to <cid>=1 (mandatory), refer to document [5]

- Maximum active PDP contexts in the IP Easy Environment at the same time: refer to chapter 3 feature 0, and chapter 4.2.1. The table shows, for example, active the PDP contexts identified by <cid>=1, and <cid>=3.

The first six sockets belong to the Multi-socket (IP Easy environment). You can use them through the #SD, #SA, etc. commands described before. Each protocol has its own service socket not belonging to the Multi-socket set.

IP Easy Multi-Socket <connId>	<cid>=1 Active	<cid>=2 No active	<cid>=3 Active	<cid>=4 No active	<cid>=5 No active
1	bound	/	/	/	/
2	bound	/	/	/	/
3	bound	/	/	/	/
4	/	/	bound	/	/
5	/	/	bound	/	/
6	/	/	bound	/	/
Protocol Service Sockets					
HTTP	bound	/	/	/	/
FTP	bound				
SMTP	bound				
PING	bound				
SSL	bound				

Tab. 12: 2G/3G Multi-Socket & Protocol Sockets

9.2. 4G Modules

9.2.1. #PROTOCOLCFG Command

4G modules provide the #PROTOCOLCFG command to change the default binding configuration between protocols (FTP, SMTP, PING, SSL, etc.) and <cid> value identifier. Here is the command syntax.

AT#PROTOCOLCFG =<protocol>,<cid>

To get parameters descriptions see documents [4], or [13] according to the module used.



#PROTOCOLCFG command is not available for Platform Version ID 30, 37.

9.2.2. Platform Version ID 20

9.2.2.1. Modules: LE910 Series

Modules: LE910-EU1, B1-EU, -JN1, -NA1, B1-NA, B1-SA, -NA V2, B4-NA, -EU V2, AU V2

The AT#PROTOCOLCFG=? test command returns the supported protocols, and for each protocol shows the <cid> range. Refer to document [4] to get parameters descriptions.

AT#PROTOCOLCFG=?

```
#PROTOCOLCFG: "FTP",{0-15},{0},{0},{0}
#PROTOCOLCFG: "SMTP",{0-15},{0},{0},{0}
#PROTOCOLCFG: "PING",{0-15},{0},{0},{0}
#PROTOCOLCFG: "SSL",{0-15},{0},{0},{0}
#PROTOCOLCFG: "NTP",{0-15},{0},{0},{0}
OK
```

The AT#PROTOCOLCFG? read command returns the current setting. The following is the default setting.

AT#PROTOCOLCFG?

```
#PROTOCOLCFG: "FTP",1,0,0,0
#PROTOCOLCFG: "SMTP",1,0,0,0
#PROTOCOLCFG: "PING",1,0,0,0
```

```
#PROTOCOLCFG: "SSL",1,0,0,0
#PROTOCOLCFG: "NTP",1,0,0,0
OK
```

The AT+CGDCONT? read command returns the current setting for each defined PDP context. The following is the default setting.

```
AT+CGDCONT?
+CGDCONT: 1,"IPV4V6","", "",0,0
OK
```

By default, the protocols service sockets are configured to use the PDP context identified by <cid>=1 but, <cid>=1 - by default - identifies a PDP context without the Access Point Name. It means that, during the attach procedure, the network assigns to <cid>=1 the Default EPS Bearer that supports the services provided by the used Network Operator. Use the #PROTOCOLCFG command to change the default configuration, in accordance with your application.

Table below summarizes how <cid> and sockets can be used.

Sockets	<cid>=1	<cid>=2	<cid>=3	<cid>=4	<cid>=5 - 15
Internal Sockets (not directly accessible to the user)	During the attach procedure, the network assigns to the module the Default EPS Bearer that supports the services provided by the used Network Operator. By default, is used <cid>=1 bound to an internal socket. See chapter 5.1.				
IP Easy Multi-Socket <connId>					
1 - 10					
Protocol Service Sockets					
FTP					
SMTP					
PING					
SSL					
NTP					

Tab. 13: LE910-EU1, Network Operator Service, Multi-Socket and Protocols

The Fig. 6 summarizes an example of configuration of Multi-socket, Protocol Services, Internal Sockets, Network Interface, and <cid>.

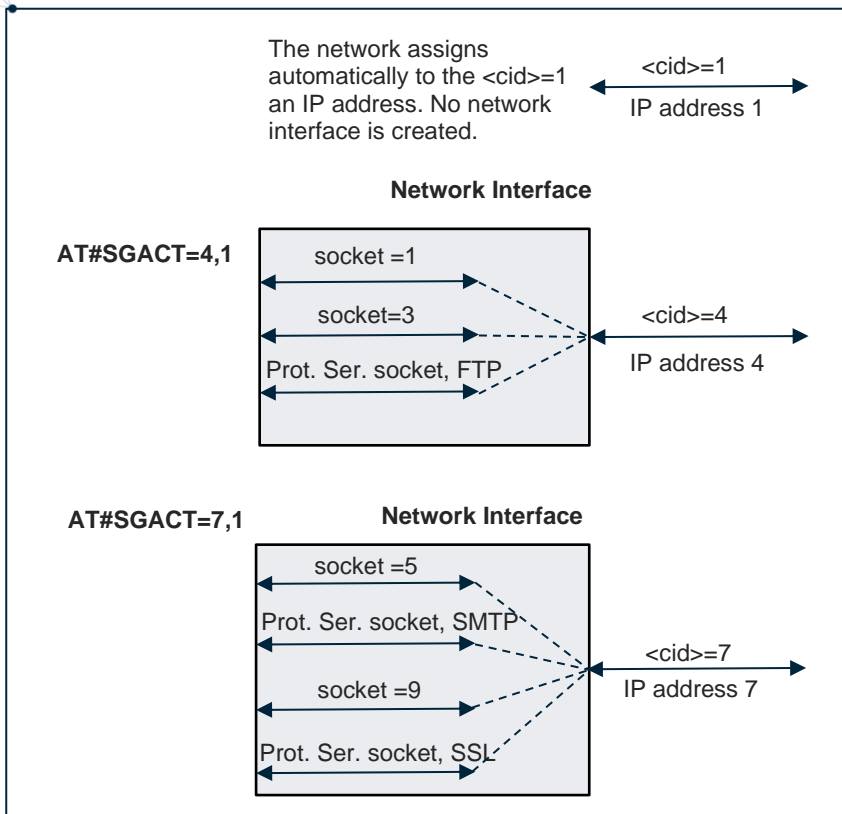

Figure 6: LE910-EU1, Multi/Protocol/Internal Sockets, and Network Interface

9.2.2.2. Modules: LE910-SV1, -SVL, SV V2

The AT#PROTOCOLCFG=? test command returns the supported protocols, and for each protocol shows the <cid> range. Refer to document [4] to get parameters descriptions.

AT#PROTOCOLCFG=?

```
#PROTOCOLCFG: "FTP", (0-15), (0), (0), (0)
#PROTOCOLCFG: "SMTP", (0-15), (0), (0), (0)
#PROTOCOLCFG: "PING", (0-15), (0), (0), (0)
#PROTOCOLCFG: "SSL", (0-15), (0), (0), (0)
#PROTOCOLCFG: "NTP", (0-15), (0), (0), (0)
OK
```

The AT#PROTOCOLCFG? read command returns the current setting. The default setting is the following.

AT#PROTOCOLCFG?

```
#PROTOCOLCFG: "FTP", 3, 0, 0, 0
#PROTOCOLCFG: "SMTP", 3, 0, 0, 0
#PROTOCOLCFG: "PING", 3, 0, 0, 0
#PROTOCOLCFG: "SSL", 3, 0, 0, 0
#PROTOCOLCFG: "NTP", 3, 0, 0, 0
OK
```

The AT+CGDCONT? read command returns the current setting for each defined PDP context. The default setting is the following.

AT+CGDCONT?

```
+CGDCONT: 1,"IPV4V6","vzwims","",0,0      Service: IMS
+CGDCONT: 2,"IPV4V6","vzwapadmin","",0,0    Service: ADMIN
+CGDCONT: 3,"IPV4V6","vzwinternet","",0,0   Service: INTERNET
OK
```

By default, the protocols service sockets are using the PDP context identified by <cid>=3 which is used – by default - by the INTERNET service as shown by the command above. Use the #PROTOCOLCFG command to change the default configuration, in accordance with your application.

Table below summarizes how <cid> and sockets can be used.

Sockets	<cid>=1	<cid>=2	<cid>=3	<cid>=4/5	<cid>=6	<cid>=7 - 15
Internal Sockets (not directly accessible to the user)	By default, <cid>=1 is used for IMS Service assigned by the Network Operator and is bound to an internal socket.	By default, <cid>=2 is used for ADMIN Service assigned by the Network Operator and is bound to an internal socket.	By default, <cid>=3 is used for INTERNET Service assigned by the Network Operator and is bound to an internal socket.	Unused	By default, <cid>=6 is used for INTERNET Service assigned by the Network Operator and is bound to an internal socket.	
IP Easy Multi-Socket <connId>	The user can bind all <cid> to sockets belonging to the Multi-socket environment, and Protocol Service Sockets, at the same time.					
1 - 10						
Protocol Service Sockets						
FTP						
SMTP						
PING						
NTP						

Tab. 14: LE910-SV1, IMS, ADMIN, INTERNET Services, Multi-Socket and Protocols

9.2.3. Platform Version ID 25

9.2.3.1. Modules: LE910Cx

The AT#PROTOCOLCFG=? test command returns the supported protocols, and for each protocol shows the <cid> range. Refer to document [13] to get parameters descriptions.

AT#PROTOCOLCFG=?

```
#PROTOCOLCFG: "FTP", (1-5), (0), (0), (0)
#PROTOCOLCFG: "SMTP", (1-5), (0), (0), (0)
#PROTOCOLCFG: "PING", (1-5), (0), (0), (0)
#PROTOCOLCFG: "SSL", (1-5), (0), (0), (0)
```

OK

The AT#PROTOCOLCFG? read command returns the current setting.
The default setting is the following.

AT#PROTOCOLCFG?

```
#PROTOCOLCFG: "FTP", 1, 0, 0, 0
#PROTOCOLCFG: "SMTP", 1, 0, 0, 0
#PROTOCOLCFG: "PING", 1, 0, 0, 0
#PROTOCOLCFG: "SSL", 1, 0, 0, 0
```

OK

The AT+CGDCONT? read command returns the current setting for each defined PDP context. The following is the default setting.

AT+CGDCONT?

```
+CGDCONT: 1, "IPV4V6", "", "", 0, 0, 0, 0
```

OK

By default, the protocols service sockets are configured to use the PDP context identified by <cid>=1 but, <cid>=1 - by default - identifies a PDP context without the Access Point Name. It means that, during the attach procedure, the network assigns to <cid>=1 the Default EPS Bearer that supports the services provided by the used Network Operator. Use the #PROTOCOLCFG command to change the default configuration, in accordance with your application.

Table below summarizes how <cid> and sockets can be used.

Sockets	<cid>=1	<cid>=2	<cid>=3	<cid>=4	<cid>=5 - 15
Internal Sockets (not directly accessible to the user)	During the attach procedure, the network assigns to the module the Default EPS Bearer that supports the services provided by the used Network Operator. By default, is used <cid>=1 bound to an internal socket. See chapter 5.1.				
IP Easy Multi-Socket <connId>	The user can bind all <cid> to sockets belonging to the Multi-socket environment, and Protocol Service Socket, at the same time.				
1 - 10					
Protocol Service Sockets					
FTP					
SMTP					
PING					
SSL					

Tab. 15: LE910Cx, Network Operator Service, Multi-Socket and Protocols

10. HTTP PROTOCOL

HTTP protocol is used in World Wide Web. To establish an HTTP connection, you can use:

I. the #HTTPQRY/#HTTPSND commands, that create an HTTP Protocol Service socket, and establishes the HTTP connection.

Assume to use #PORTCFG command or CMUX tool, the module can provide three serial lines connected to three AT parsers, see Fig. 2 and Fig. 3

Suppose that one HTTP connection is already started and not still closed on a serial port. If you try to open a second HTTP connection on another serial port, the #HTTPQRY/#HTTPSND commands return an error message. When the old HTTP connection is closed, you can open the new one.

II. the #SD command that uses a Multi-socket, see chapter 10.4.4. In this case, the user application must manage the HTTP protocol.

10.1. #HTTPCFG Command

Use #HTTPCFG command to set one of the three profiles, provided by modules, to configure an HTTP connection. The profiles are identified by the <prof_id> parameter and are automatically saved in NVM.

10.1.1. 2G Modules

```
AT#HTTPCFG=<prof_id>[,<server_address>[,<server_port>[,<auth_type>
[,<username>[,<password>[,<ssl_enable>[,<timeout>[,<cid> ]]]]]]]]
```

The AT#HTTPCFG=? test command returns the supported range of parameters value. Example: <prof_id> range: 0-2, <cid> range: 1-5.

```
AT#HTTPCFG=?
#HTTPCFG: (0-2),50,(1-65535),(0,1),50,50,(0,1),(1-65535),(1-5)
OK
```

Referring to the example shown in Tab. 16:

- HTTP Service socket bound to <cid>=1 (by default, it can be changed)
- Sockets <connId>= 1, 2, 3 not opened, and bound to active <cid>=1
- Sockets <connId>= 4, 5, 6 not opened, and bound to active <cid>=3

IP Easy Multi-Socket <connId>	<cid>=1 Active	<cid>=2 No active	<cid>=3 Active	<cid>=4 No active	<cid>=5 No active
1	bound	/	/	/	/
2	bound	/	/	/	/
3	bound	/	/	/	/
4	/	/	bound	/	/
5	/	/	bound	/	/
6	/	/	bound	/	/
Protocol Service Sockets					
HTTP Service Socket	bound (default)	/	/	/	/

Tab. 16: 2G Multi-Socket & HTTP Service Socket

The AT#HTTPCFG? read command returns the current setting for each profile with the following format:

```
#HTTPCFG:<prof_id>,<server_address>,<server_port>,<auth_type>,<username>,<password>,<ssl_enabled>,<timeout>,<cid><CR><LF>
```

These are the default profiles

AT#HTTPCFG?

```
#HTTPCFG: 0,"",80,0,"","*****",0,120,1
```

```
#HTTPCFG: 1,"",80,0,"","*****",0,120,1
```

```
#HTTPCFG: 2,"m2mlocate.telit.com",9978,0,"","*****",0,120,1
```

OK

Use AT#HTTPCFG=<prof_id> command form to reset the values of the <prof_id> profile and set the default values.

See documents [1] to get parameters descriptions.

10.1.2. 3G Modules

```
AT#HTTPCFG=<prof_id>[,<server_address>[,<server_port>[,<auth_type>[,<username>[,<password>[,<ssl_enable>[,<timeout>[,<cid>[,<pkt_size>[,<unused_1>[,<unused_2>]]]]]]]]]]
```

The AT#HTTPCFG=? test command returns the supported range of parameters values.
 Example: <prof_id> range: 0-2, <cid> range: 1-5.

AT#HTTPCFG=?

#HTTPCFG: (0-2),50,(1-65535),(0,1),50,50,(0,1),(1-65535),(1-5),(0-1500),(0),(0)
 OK

Referring to the example shown in Tab. 17:

- HTTP Service socket bound to <cid>=1 (by default, it can be changed)
- Sockets <connId>= 1, 2, 3 not opened, and bound to active <cid>=1
- Sockets <connId>= 4, 5, 6 not opened, and bound to active <cid>=3

IP Easy Multi-Socket <connId>	<cid>=1 Active	<cid>=2 No active	<cid>=3 Active	<cid>=4 No active	<cid>=5 No active
1	bound	/	/	/	/
2	bound	/	/	/	/
3	bound	/	/	/	/
4	/	/	bound	/	/
5	/	/	bound	/	/
6	/	/	bound	/	/
Protocol Service Sockets					
HTTP Service Socket	bound (default)	/	/	/	/

Tab. 17: 3G Multi-Socket & HTTP Service Socket

The AT#HTTPCFG? read command returns the current setting for each profile with the following format:

#HTTPCFG:<prof_id>,<server_address>,<server_port>,<auth_type>,<username>,<password>,<ssl_enabled>,<timeout>,<cid>,<pkt_size>,0,0<CR><LF>

These are the default profiles

AT#HTTPCFG?

#HTTPCFG: 0,"",80,0,"","*****",0,120,3,300,0,0
 #HTTPCFG: 1,"",80,0,"","*****",0,120,3,300,0,0
 #HTTPCFG: 2,"m2mlocate.telit.com",9978,0,"","*****",0,120,3,300,0,0
 OK

Use AT#HTTPCFG=<prof_id> command form to reset the values of the <prof_id> profile and set the default values.

See documents [2] to get parameters descriptions.

10.1.3. 4G Modules

```
AT#HTTPCFG=<prof_id>[,<server_address>[,<server_port>[,<auth_type>
    [,<username>[,<password>[,<ssl_enabled>[,<timeout>[,<cid>[,<pkt_size>
    ,<unused1>[,<unused2>]]]]]]]]]]]
```

The AT#HTTPCFG=? test command returns the supported range of parameters values based on the module used, see the following sub-chapters.

The AT#HTTPCFG? read command returns the current setting for each profile with the following format:

```
#HTTPCFG:<prof_id>,<server_address>,<server_port>,<auth_type>,
<username>,<password>,<ssl_enabled>,<timeout>,<cid>,<pkt_size>,0,0<CR><LF>
```

These are the default profiles

```
AT#HTTPCFG?
```

```
#HTTPCFG: 0,"",80,0,"", "*****",0,120,3,300,0,0
```

```
#HTTPCFG: 1,"",80,0,"", "*****",0,120,3,300,0,0
```

```
#HTTPCFG: 2,"m2mlocate.telit.com",9978,0,"", "*****",0,120,3,300,0,0
```

```
OK
```

Use AT#HTTPCFG=<prof_id> command form to reset the values of the <prof_id> profile and set the default values.

To get parameters descriptions see documents [4], [11], [13], [14] or [15] according to the module used.

10.1.3.1. Platform Version ID 20



Use the #PROTOCOLCFG command to change the default binding between the HTTP Application and <cid> identifier.

10.1.3.1.1. Modules: LE910 Series

Modules: LE910-EU1, B1-EU, -JN1, -NA1, B1-NA, B1-SA, -NA V2, B4-NA, -EU V2, AU V2

The AT#HTTPCFG=? test command returns the supported range of parameters values.
Pay attention to: <prof_id> range: 0-2, <cid> range: 1-15.

AT#HTTPCFG=?

#HTTPCFG: (0-2),50,(1-65535),(0,1),50,50,(0,1),(1-65535),(1-15),(0-1500),(0),(0)
OK

10.1.3.1.2. Modules: LE910-SV1, -SVL, SV V2

The AT#HTTPCFG=? test command returns the supported range of parameters values.
Pay attention to: <prof_id> range: 0-2, <cid> range: 1-15.

AT#HTTPCFG=?

#HTTPCFG: (0-2),50,(1-65535),(0,1),50,50,(0,1),(1-65535),(1-15),(0-1500),(0),(0)
OK

10.1.3.2. Platform Version ID 23

10.1.3.2.1. Modules: LE866-SV1, ME866A1-NV

The AT#HTTPCFG=? test command returns the supported range of parameters values.
Pay attention to: <prof_id> range: 0-2, <cid> range: 1-5.

AT#HTTPCFG=?

#HTTPCFG: (0-2),50,(1-65535),(0,1),50,50,(0,1),(1-65535),(1-5),(0-1500),(0),(0)
OK

10.1.3.3. Platform Version ID 25

10.1.3.3.1. Modules: LE910Cx

The AT#HTTPCFG=? test command returns the supported range of parameters values.
Pay attention to: <prof_id> range: 0-2, <cid> range: 1-5.

AT#HTTPCFG=?

#HTTPCFG: (0-2),63,(1-65535),(0,1),50,50,(0),(1-65535),(1-5)

OK

10.1.3.4. Platform Version ID 30, 37

```
AT#HTTPCFG=<prof_id>[,<server_address>[,<server_port>[,<auth_type>
    [,<username>[,<password>[,<ssl_enabled>[,<timeout>[,<cid>[,<pkt_size>
    [,<unused1>[,<unused2>]]]]]]]]]]]
```

To get more information, refer to documents [14] or [15] according to the module used.

10.2. #HTTPQRY: GET, HEAD, DELETE

Use the #HTTPQRY command to send an HTTP command request (GET, HEAD, DELETE, see RFC 2616 document) to the HTTP server. If the request succeeds, the #HTTPQRY command returns the OK message, otherwise an error code is reported.

#HTTPQRY sends the HTTP request header containing the "Connection: close" option, see RFC 2616 document, and it cannot be removed. The "close" connection option signals that the connection will be closed after the current request/response is complete.

```
AT#HTTPQRY=<prof_id>,<command>,<resource>[,<extra_header_line>]
```

When the HTTP server answer is received, then the following URC is put on the serial port:

```
#HTTTPRING: <prof_id>,<http_status_code>,<content_type>,<data_size>
```

To get parameters descriptions, refer to 4G documents according to the module used.

NOTES:

I. If there are no data from server or the server does not answer within the time interval specified in <timeout> parameter of #HTTPCFG command, then the URC #HTTTPRING <http_status_code> parameter has value 0.

II. The time required to receive the #HTTTPRING URC could be greater than the one specified in <timeout> parameter of #HTTPCFG command, because it also includes the time needed to send the HTTP request to the server.

- III. To set more than one HTTP header line in parameter <extra_header_line>, they have to be separated by ">>"

10.3. #HTTPSND: POST, PUT

Use the #HTTPSND command to send data to HTTP server using POST or PUT HTTP command requests, see RFC 2616 document. After command line is terminated with <CR>, the command responds with the following three characters: >>>. Now, you can digit the characters to send to the server. If the operation succeeds, the #HTTPSND command returns the OK message, otherwise an error code is reported.

#HTTPSND sends the HTTP request header containing the "Connection: close" option, see RFC 2616 document, and it cannot be removed. The "close" connection option signals that the connection will be closed after the current request/response is complete.

```
AT#HTTPSND=<prof_id>,<command>,<resource>,<data_len>[,<post_param>
                                     [,<extra_header_line>]]
```

When the HTTP server answer is received, the following URC is displayed on the DTE:

```
#HTTTPRING: <prof_id>,<http_status_code>,<content_type>,<data_size>
```

To get parameters descriptions, refer to 4G documents according to the module used.

NOTES:

- I. If no data are received from the HTTP server, or the HTTP server does not answer within the time interval specified in <timeout> parameter of #HTTTPCFG command, then the <http_status_code> parameter of the #HTTTPRING URC is 0.
- II. The time required to receive the #HTTTPRING URC could be greater than the one specified in <timeout> parameter of #HTTTPCFG command, because it also includes the time needed to send the HTTP request to the server.

10.4. Examples

10.4.1. GET Command (2G)

This example shows the use of the GET command.

Define PDP context <cid=1>.

```
AT+CGDCONT=1,"IP", "Access_Point_Name"  
OK
```

Activate PDP Context <cid>=1. The #SGACT command returns the IP address assigned by the network to the module.

```
AT#SGACT=1,1  
#SGACT: 10.7.125.7  
OK
```

Configure the HTTP server parameters.

```
AT#HTTPCFG=0,"server_address",80,0,,,0,120,1  
OK
```

Use #HTTPQRY to open the HTTP connection and send the GET command to the HTTP server. The connection will be close after completion of the response ("Connect: close" option).

```
AT#HTTPQRY=0,0,"/"  
OK
```

← GET command succeeds.

When the HTTP server answer is received, the HTTP connection is closed, and a URC is displayed on the terminal emulator.

```
#HTTTPRING: 0,200,"text/html", ...
```

Type in the #HTTTPRCV command to read data sent by HTTP server and stored in the socket buffer.

```
AT#HTTTPRCV=0  
<!doctype html>  
<html>  
.....  
</html>  
OK
```

10.4.2. POST Command (2G)

This example shows the use of the POST command.

Define PDP context.

```
AT+CGDCONT=1,"IP","Access_Point_Name"
```

```
OK
```

Context activation.

```
AT#SGACT=1,1
```

```
#SGACT: 10.7.125.7
```

```
OK
```

Configure HTTP server parameters.

```
AT#HTTPCFG=0,"server_address",80,0,,,0,120,1
```

```
OK
```

Use #HTTPSND to open the HTTP connection and send the POST command to the HTTP server. The connection will be close after completion of the response ("Connect: close" option). In this example, you digit 27 characters.

```
AT#HTTPSND=0,0,"/",27
```

```
>>> digit 27 characters
```

```
OK
```

When the HTTP server answer is received, the following URC is put on the serial port.

```
#HTTTPRING: 0,200,"text/html",1270
```

```
AT#HTTTPRCV=0
```

```
<!doctype html>
```

```
<html>
```

```
<head>
```

```
<title>Example POST response</title> ...
```

```
OK
```

10.4.3. PUT Command (2G)

This example shows the use of the PUT command.

Define PDP context.

```
AT+CGDCONT=1,"IP","Access_Point_Name"  
OK
```

Context activation.

```
AT#SGACT=1,1  
#SGACT: 10.7.125.7  
OK
```

Configure HTTP server parameters.

```
AT#HTTPCFG=0,"server_address",80,0,,,0,120,1  
OK
```

Use #HTTPSND to open the HTTP connection and send the PUT command to the HTTP server. The connection will be close after completion of the response ("Connect: close" option). In this example, you digit 27 characters.

```
AT#HTTPSND=0,1,"/",27  
>>> digit 27 characters  
OK
```

When the HTTP server answer is received, the following URC is put on the serial port.

```
#HTTTPRING: 0,200,"text/html",1270
```

```
AT#HTTTPRCV=0  
<!doctype html>  
<html>  
<head>  
<title>Example PUT response</title> ...  
OK
```

10.4.4. HTTP Client with #SD

This example establishes an HTTP connection toward an HTTP server and retrieves an HTML page using a socket dial connection (#SD). Assume that a terminal emulator is connected to the module. See, for comparison, the example described in chapter 14.3.3.

Check the sockets/PDP contexts binding configuration (default).

AT#SCFG?

#SCFG: 1,1,300,90,600,50

#SCFG: 2,1,300,90,600,50

#SCFG: 3,1,300,90,600,50

#SCFG: 4,2,300,90,600,50

#SCFG: 5,2,300,90,600,50

#SCFG: 6,2,300,90,600,50

OK

Define PDP Context <cid>=1.

AT+CGDCONT = 1,"IP","Access_Point_Name","0.0.0.0",0,0

OK

Check which are the currently defined PDP contexts.

AT+CGDCONT?

+CGDCONT: 1,"IP","Access_Point_Name","0.0.0.0",0,0

OK

Activate the PDP context <cid>=1, assume that no UserID and Password are needed. The command returns the IP address assigned by the network to the module.

AT#SGACT=1,1

#SGACT: 2.43.168.172

OK

Open the connection toward the HTTP server on port=80. Transport protocol is TCP.

AT#SD=1,0,80,"server_address",0,0

CONNECT ← the connection is open. The module is in ONLINE mode.

Now, following the HTTP protocol, ask the homepage by sending the next lines to the module. The entered data are sent directly to the HTTP server. The strings sent to the HTTP server must be ended by line feed character. Enable the local echo on terminal emulator to see the issued commands.

GET / HTTP/1.1<cr><lf>

Host: www.telit.com<cr><lf>

Connection: keep-alive<cr><lf>

<cr><lf>

The HTTP server replies with the HTML code of the homepage and some debugging responses.

HTTP/1.1 200 OK

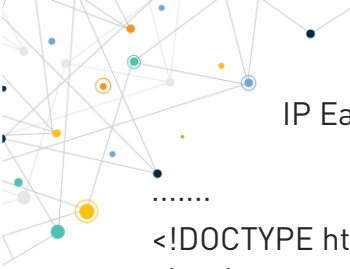

.....
<!DOCTYPE html>
<html>
... here is all the HTML code of the page ...
</html>

NO CARRIER ← HTTP connection is closed.

Check the disconnection cause.

AT#SLASTCLOSURE=1
#SLASTCLOSURE: 1,1 ← HTTP connection closed by remote host.
OK

11. SMTP PROTOCOL

SMTP is a standard protocol for electronic mail (e-mail). To establish a SMTP connection, you can use:

- I. the #EMAILD/#SMTPCL commands, that create a SMTP Protocol Service socket, and establishes the SMTP connection.

Assume to use #PORTCFG command or CMUX tool, the module can provide three serial lines connected to three AT parsers, see Fig. 2 and Fig. 3.

Suppose that one SMTP connection is already started and not still closed on a serial port. If you try to open a second SMTP connection on another serial port, the #EMAILD/ #SMTPCL commands return an error message. When the old SMTP connection is closed, you can open the new one.

- II. the #SD command that uses a Multi-socket, as shown by the examples in chapters 11.6.3, and 11.6.4. In this case, the user application must manage the SMTP protocol.

11.1. 2G Modules

The SMTP connection can use only the PDP Context identified by <cid>=1, or the GSM context identified by <cid>=0. The SMTP command uses one of the two contexts according to the command previously entered: AT#SGACT=1,1 or AT#SGACT =0,1 respectively. For GSM context (<cid>=0) see chapter 14.3.5.

Use #SMTPCFG command to configure the SMTP connection. The command syntax is:

```
AT#SMTPCFG=<ssl_enable>[,<port>[,<mode>[,<charset>[,<UNUSED_1>
                                                    [,<UNUSED_2>]]]]]
```

See document [1] to get parameters descriptions.

Referring to the example shown in Tab. 18:

- SMTP Service socket bound to <cid>=1 (mandatory)
- Sockets <connId>= 1, 2, 3 not opened, and bound to active <cid>=1
- Sockets <connId>= 4, 5, 6 not opened, and bound to active <cid>=3

IP Easy Multi-Socket <connId>	<cid>=1 Active	<cid>=2 No active	<cid>=3 Active	<cid>=4 No active	<cid>=5 No active
1	bound	/	/	/	/
2	bound	/	/	/	/
3	bound	/	/	/	/
4	/	/	bound	/	/
5	/	/	bound	/	/
6	/	/	bound	/	/
Protocol Service Sockets					
SMTP Service Socket	bound				

Tab. 18: 2G Multi-Socket & SMTP Service Socket

11.2. 3G Modules

The SMTP connection can use only the PDP Context identified by <cid>=1, or the GSM context identified by <cid>=0, both settings are mandatory. The SMTP command selects one of the two contexts according to the command previously entered: AT#SGACT=1,1 or AT#SGACT=0,1 respectively. For GSM context (<cid>=0) see chapter 14.3.5.

AT#SMTPCFG=<ssl_enable>[,<port>[,<mode>[,<UNUSED_1>[,<pkt_size>[,<UNUSED_2]]]]]

See document [2] to get parameters descriptions.

Referring to the example shown in Tab. 19:

- SMTP Service socket bound to <cid>=1 (mandatory)
- Sockets <connId>= 1, 2, 3 not opened, and bound to active <cid>=1
- Sockets <connId>= 4, 5, 6 not opened, and bound to active <cid>=3

IP Easy Multi-Socket <connId>	<cid>=1 Active	<cid>=2 No active	<cid>=3 Active	<cid>=4 No active	<cid>=5 No active
1	bound	/	/	/	/
2	bound	/	/	/	/
3	bound	/	/	/	/
4	/	/	bound	/	/
5	/	/	bound	/	/
6	/	/	bound	/	/
Protocol Service Sockets					
SMTP Service Socket	bound				

Tab. 19: 3G Multi-Socket & SMTP Service Socket

11.3. 4G Modules

11.3.1. Platform Version ID 20, 23

AT#SMTPCFG=<ssl_enable>[,<port>[,<mode>[,<unused_1>[,<pkt_size>[,<unused_2>]]]]]

To get parameters descriptions, refer to documents [4] or [11] according to the module used.

For platform ID 20 use #PROTOCOLCFG command to change the <cid> identifier bound to SMTP protocol, refer to chapter 9.2.

11.3.2. Platform Version ID 25

AT#SMTPCFG=<ssl_enabled>[,<port>[,<mode>[,<UNUSED_1>[,<UNUSED_2>[,<UNUSED_3>]]]]]

To get parameters descriptions, refer to document [13].

11.3.3. Platform Version ID 30, 37

AT#SMTPCFG=<ssl_enabled>[,<port>[,<mode>[,<unused1>[,<unused2>[,<cid>]]]]]

To get parameters descriptions, refer to documents [14] or [15] according to the module used.

11.4. E-mail Sending, with no Attachment

Use the #EMAILD command to send an e-mail to the SMTP server. When you enter the command, and the following <CR>, the command returns the ">" prompt and waits for the message body text. To close the message, enter Ctrl-Z (char 0x1A), to exit without writing the message enter ESC (char 0x1B).

AT#EMAILD=[<da>,<subj>]

If e-mail message is successfully sent, the command returns the OK message, otherwise returns an error code.

To get parameters descriptions, see documents [1], [2], [4], [11], [13], [14] or [15] according to the module used.

11.5. E-mail Sending, with Attachment

Use the #SMTPCL command to send an e-mail with attachment.

AT#SMTPCL=<da>,<subj>,<att>[,<filename>,<encod>]

To get parameters descriptions, see documents [1], [2], [4], or [11], according to the module used.



Platform Version ID 25, 30, 37 do not support AT#SMTPCL command.

11.6. Examples

11.6.1. With no Attachment

This example shows how to send an e-mail to a recipient. A terminal emulator is connected to the module.

Enable error in verbose format.

```
AT+CMEE=2
OK
```

Define PDP context <cid>=1.

```
AT+CGDCONT=1,"IP", "Access_Point_Name"
OK
```

To activate successfully a PDP context, it must be bound to a socket by means of the #SCFG command.

Assume that no username and password are required to activate it. The command returns the IP address assigned by the network to the module.

```
AT#SGACT=1,1
#SGACT: 10.7.125.7
OK
```

Set the SMTP connection parameters.

```
AT#SMTPCFG=0,587
OK
```

```
AT#ESMTP="SMTP_server_address" ← config. SMTP server address of the sender.
OK
```

```
AT#EADDR="sender_address" ← configure e-mail address of the sender.
OK
```

```
AT#EUSER="sender_user_name" ← configure username of the sender.
OK
```

```
AT#EPASSW="sender_user_password" ← configure user password of the sender.
OK
```

Send the e-mail with no attachment to the recipient having recipient_address.

```
AT#EMAILD="recipient_address","mail with no attachment"
> Hello<Ctrl-Z>
```

OK

← text of the e-mail has been sent successfully.

11.6.2. With Attachment

This example shows how to send an e-mail to a recipient with an attachment. A terminal emulator is connected to the module.

Enable error in verbose format.

```
AT+CMEE=2
```

OK

Define PDP context.

```
AT+CGDCONT=1,"IP", "Access_Point_Name"
```

OK

To activate successfully a PDP context, it must be bound to a socket by means of the #SCFG command.

The command returns the IP address assigned by the network to the module.

```
AT#SGACT=1,1
```

```
#SGACT: 10.7.125.7
```

OK

Set the SMTP connection parameters.

```
AT#SMTPCFG=0,587
```

OK

```
AT#ESMTP="SMTP_server_address"
```

← config. SMTP server address of the sender.

OK

```
AT#EADDR="sender_address"
```

← configure e-mail address of the sender.

OK

```
AT#EUSER="sender_user_name"
```

← configure username of the sender.

OK

```
AT#EPASSW="sender_user_password"
```

← configure user password of the sender.

OK

Send the e-mail, with a picture in the attachment, to the recipient having recipient_address.

```
AT#SMTPCL="recipient_address","mail with picture",2,"picture.jpg"  
> Hello.<CR><LF>  
This is the body.<CR><LF>  
The picture is in the attachment.<CR><LF><Ctrl-Z>
```

CONNECT ← the module enters ONLINE mode to send the attachment.

... binary data of the attachment ...

+++ ← type in the escape sequence to close the connection.

NO CARRIER ← the module returns this message and enters COMMAND mode.

11.6.3. Sending with #SD

This example describes how to create a SMTP connection, and send an e-mail using the socket dial command (#SD). The socket is one of the sockets provided by the Multi-socket feature. Assume that a terminal emulator is connected to the module.

Enable reports in verbose format.

```
AT+CMEE=2
```

```
OK
```

Define PDP context <cid>=1.

```
AT+CGDCONT=1,"IP", "Access_Point_Name"
```

```
OK
```

To activate successfully a PDP context, it must be bound to a socket by means of the #SCFG command.

Assume that no username and password are required to activate it. The command returns the IP address assigned by the network to the module.

```
AT#SGACT=1,1
```

```
#SGACT: 193.199.234.255
```

```
OK
```

Open the connection toward the SMTP server using "SMTP_server_address" and port 25.

```
AT#SD=1, 0,25," SMTP_server_address ",0,0
```

CONNECT ← the module is in ONLINE mode

Now, the user application sends the SMTP protocol commands: HELO, MAIL FROM, RCPT TO, DATA, QUIT.

.....

+++ ← type in the escape sequence to suspend the connection.

OK ← the module is in COMMAND mode.

AT#SH=1

OK ← the connection is closed.

11.6.4. Receiving with #SD

This example describes how to create a connection toward a POP server, and receive an e-mail using a socket dial command (#SD). The socket is one out of the N provided by the Multi-socket feature. A terminal emulator is connected to the module.

Enable reports in verbose format.

AT+CMEE=2

OK

Define PDP context <cid>=1.

AT+CGDCONT=1,"IP", "Access_Point_Name"

OK

Configure the socket <connId>=1 and bind it to PDP context <cid>=1.

AT#SCFG=1,1,300,90,600,50

OK

To activate successfully a PDP context, it must be bound to a socket by means of the #SCFG command.

Assume that no username and password are required to activate it. The command returns the IP address assigned by the network to the module.

AT#SGACT=1,1

#SGACT: 193.199.234.255

OK

Open the connection toward the POP server on port=110. Transport protocol is TCP.

AT#SD=1,0,110,"POP_server_address",0,0



CONNECT ← the module is in ONLINE mode.

Now, the user application uses the POP3 protocol.

.....
.....
.....

+++ ← type in the escape sequence to suspend the connection.

OK ← the module is in COMMAND mode.

AT#SH=1

OK ← the connection is closed.

12. FTP PROTOCOL

FTP is a standard network protocol used to transfer files between a client and server on a network. To establish an FTP connection, you can use:

- I. the #FTPOPEN command, that creates an FTP Protocol Service socket, and establishes the FTP control connection. Then, you can use #FTPGET or #FTPGET command to open the next data connection.

Assume to use #PORTCFG command or CMUX tool, the module can provide three serial lines connected to three AT parsers, see Fig. 2 and Fig. 3.

Suppose that one FTP control connection is already started on a serial port. If you try to open a second FTP control connection on another serial port, the #FTPOPEN command returns an error message. Close the old FTP control connection, to open the new one. See example in chapter 12.3.1.

- II. the #SD command that uses a Multi-socket. In this case, the user application must manage the FTP protocol.

12.1. 2G/3G Modules

The FTP connection can use only the PDP Context identified by <cid>=1, or the GSM context identified by <cid>=0. The FTP command uses one of the two contexts according to the command previously entered: AT#SGACT=1,1 or AT#SGACT =0,1 respectively. For GSM context (<cid>=0) see chapter 14.3.4.

Use #FTPOPEN command to open an FTP connection (control connection). The command syntax is:

```
AT#FTPOPEN=[<server:port>,<username>,<password>[,<mode>]]
```

Referring to the example shown in the table below:

- FTP Service socket bound to <cid>=1 (mandatory)
- Sockets <connId>= 1, 2, 3 not opened, and bound to active <cid>=1
- Sockets <connId>= 4, 5, 6 not opened, and bound to active <cid>=3

IP Easy Multi-Socket <connId>	<cid>=1 Active	<cid>=2 No active	<cid>=3 Active	<cid>=4 No active	<cid>=5 No active
1	bound	/	/	/	/
2	bound	/	/	/	/
3	bound	/	/	/	/
4	/	/	bound	/	/
5	/	/	bound	/	/
6	/	/	bound	/	/
Protocol Service Sockets					
FTP Service Socket	bound				

Tab. 20: 2G/3G Multi-Socket & FTP Service Socket

Use #FTPCLOSE command to close an FTP control connection. The command syntax is:

AT#FTPCLOSE

Refer to example 12.8.1.

To get parameters descriptions see documents [1] or [2] according to the module used.

12.2. 4G Modules

Use #FTPOPEN command to open an FTP connection (control connection). For platform Version ID 30, 37 the command syntax is (refer to document [4]):

AT#FTPOPEN=[[<server:port>,<username>,<password>,<mode>],<cid>]

To get syntax command and parameters descriptions about other platforms see documents [11], [13], [14] or [15] according to the module used.

For platform ID 20 use #PROTOCOLCFG command to change the <cid> identifier bound to FTP protocol, refer to chapter 9.2.

Use #FTPCLOSE command to close an FTP connection (control connection). The command syntax is:

AT#FTPCLOSE

Refer to example 12.8.1.

See documents [4], [11], [13], [14] or [15] according to the module used.

12.3. Examples

12.3.1. Open Six Sockets and the FTP Connection

This example shows the opening of six sockets (Multi-socket) in COMMAND mode, plus the FTP connection. It is assumed to use only one serial port; a terminal emulator is connected to the module.

Enable reports in verbose format.

```
AT+CMEE=2
```

```
OK
```

Check the socket configuration (default).

```
AT#SCFG?
```

```
#SCFG: 1,1,300,90,600,50
```

```
#SCFG: 2,1,300,90,600,50
```

```
#SCFG: 3,1,300,90,600,50
```

```
#SCFG: 4,2,300,90,600,50
```

```
#SCFG: 5,2,300,90,600,50
```

```
#SCFG: 6,2,300,90,600,50
```

```
OK
```

Check PDP contexts.

```
AT+CGDCONT?
```

```
OK
```

← no PDP context are defined.

Define PDP context <cid>=1.

```
AT+CGDCONT=1,"IP", "Access_Point_Name"
```

```
OK
```

Define PDP context <cid>=2.

```
AT+CGDCONT=2,"IP", "Access_Point_Name"
```

```
OK
```

Check PDP contexts.

```
AT+CGDCONT?
```

```
+CGDCONT: 1,"IP", "Access_Point_Name", "0.0.0.0", 0,0
```

```
+CGDCONT: 2,"IP", "Access_Point_Name", "0.0.0.0", 0,0
```

```
OK
```

To activate successfully a PDP context, it must be previously bound to a socket by means of the #SCFG command.

Activate PDP context <cid>=1. The command returns the IP address assigned by the network to the module.

```
AT#SGACT=1,1
#SGACT: 37.176.124.199
OK
```

Activate PDP context <cid>=2

```
AT#SGACT=2,1
#SGACT: 31.157.11.11
OK
```

Open the six sockets connection in COMMAND mode on echo port.

```
AT#SD=1,0,remote_host_port," remote_IP_address ",0,0,1
OK
```

```
AT#SD=2,0,remote_host_port," remote_IP_address ",0,0,1
OK
```

```
AT#SD=3,0,remote_host_port," remote_IP_address ",0,0,1
OK
```

```
AT#SD=4,0,remote_host_port," remote_IP_address ",0,0,1
OK
```

```
AT#SD=5,0,remote_host_port," remote_IP_address ",0,0,1
OK
```

```
AT#SD=6,0,remote_host_port," remote_IP_address ",0,0,1
OK
```

Before using #FTPOPEN command, the PDP context identified by <cid>=1, mandatorily assigned to the FTP Application, must be defined. Then <cid>=1 must be bound to a Multi-socket and activated through #SGACT command to create the related Network Interface. The #FTPOPEN command uses a Protocol Service Socket, but #SGACT command requires the PDP context bound to a Multi-socket.

Open an FTP connection (control port) toward the FTP server. The FTP server port is not specified; therefore, the command uses the default value 21. The FTP connection is in active mode (default).

```
AT#FTPOPEN="server","username","password"
OK ← FTP connection open, and in active mode.
```

Check the state of the six sockets (Multi-socket environment)

AT#SS

#SS: 1,2,37.176.124.199,64916,remote_IP_address, remote_host_port

#SS: 2,2,37.176.124.199,64917,remote_IP_address, remote_host_port

#SS: 3,2,37.176.124.199,64918,remote_IP_address, remote_host_port

#SS: 4,2,31.157.11.11,64919,remote_IP_address, remote_host_port

#SS: 5,2,31.157.11.11,64920,remote_IP_address, remote_host_port

#SS: 6,2,31.157.11.11,64921,remote_IP_address, remote_host_port

OK

Try to open again the FTP connection just to verify that it is already open.

AT#FTPOPEN="server","username","password"

+CME ERROR: Already connected

The table below shows the current connections configuration.

IP Easy Multi-Socket <connId>	<cid>=1 Active	<cid>=2 Active	<cid>=3 No active	<cid>=4 No active	<cid>=5 No active
1	open	/	/	/	/
2	open	/	/	/	/
3	open	/	/	/	/
4	/	open	/	/	/
5	/	open	/	/	/
6	/	open	/	/	/
Protocol Service Sockets					
FTP Service Socket	open				

Tab. 21: 2G/3G Multi-Socket & FTP Service Socket Opened

12.4. FTP Time Out Setting, #FTPTO Command

Use the #FTPTO command to set the timeout used when opening either the FTP control connection or the FTP data connection, it is not saved in NVM. If <tout> parameter is omitted, the command returns the current FTP time-out. The command syntax is:

AT#FTPTO [=<tout>]

To get parameter description see documents [1], [2], [4], [11], [13], [14] or [15] according to the module used.

Refer to example 12.8.1.

12.5. FTP Transfer Type Setting, #FTPTYPE Command

Use the #FTPTYPE command to configure the file transfer type (binary or ASCII). The command must be used after the FTP control connection has been opened. If the <type> parameter is omitted, the command returns the current file transfer type. The command syntax is:

AT#FTPTYPE=[<type>]

To get parameters descriptions see documents [1], [2], [4], [11], [13], [14] or [15] according to the module used.

Refer to example 12.8.1.

12.6. FTP Uploading, #FTPPUT, #FTPAPPEXT Command

Assume that the FTP connection is open (control connection). The #FTPPUT command opens the data connection. The command syntax is:

AT#FTPPUT =[[<filename>][,<connMode>]]

Refer to examples 12.8.1, and 12.8.2.

Use #FTPAPPEXT command to upload data into the file stored on the FTP server. The command syntax is:

AT#FTPAPPEXT=<bytestosend>[,<eof>]

Refer to example 12.8.2.

To get parameters descriptions see documents [1], [2], [4], [11], [13], [14] or [15] according to the module used.

12.7. #FTPFSIZE, #FTPAPP Commands

Use the #FTPFSIZE command to know how many bytes have been received by the FTP server if the file uploading has been interrupted during the #FTPPUT command. Enter the command during the FTP control connection. Before typing in #FTPFSIZE command, it is mandatory to issue #FTPTYPE=0 command to set binary transfer type. The command syntax is:

AT#FTPFSIZE=<filename>

Use #FTPAPP command to append the missing part of the file. Use the #FTPFSIZE response to know the restart position of the local file.

AT#FTPAPP =[[<filename>],connMode>]

To get parameters descriptions see documents [1], [2], [4], [11], [13], [14] or [15] according to the module used.

12.8. Examples

12.8.1. Data Uploading in ONLINE Mode

This example shows how to upload a file to an FTP server when the module is in ONLINE mode. A terminal emulator is connected to the module.

Enable reports in verbose format.

AT+CMEE=2

OK

Check the socket configuration (default).

AT#SCFG?

#SCFG: 1,1,300,90,600,50

#SCFG: 2,1,300,90,600,50

#SCFG: 3,1,300,90,600,50

#SCFG: 4,2,300,90,600,50

#SCFG: 5,2,300,90,600,50

#SCFG: 6,2,300,90,600,50

OK

Check the PDP contexts.

AT+CGDCONT?

OK

← no PDP context

Define PDP context <cid>=1.

AT+CGDCONT=1,"IP", "Access_Point_Name"

OK

Check the PDP contexts.

AT+CGDCONT?

+CGDCONT: 1,"IP","Access_Point_Name","0.0.0.0",0,0

OK

To activate successfully a PDP context, it must be previously bound to a socket by means of the #SCFG command.

Activate PDP context <cid>=1. The command returns the IP address assigned by the network to the module.

```
AT#SGACT=1,1
```

```
#SGACT: 193.199.234.255
```

```
OK
```

Set the FTP time-out.

```
AT#FTPTO=1000
```

```
OK
```

Before using #FTPOPEN command, the PDP context identified by <cid>=1, mandatorily assigned to the FTP Application, must be defined. Then <cid>=1 must be bound to a Multi-socket and activated through #SGACT command to create the related Network Interface. The #FTPOPEN command uses a Protocol Service Socket, but #SGACT command requires the PDP context bound to a Multi-socket.

Open an FTP connection toward the FTP server. The FTP server port is not specified; therefore, the command uses the default value 21. The FTP connection is in active mode (default).

```
AT#FTPOPEN="server","username","password"
```

```
OK ← FTP connection open and in active mode.
```

Set the file type (ASCII).

```
AT#FTPTYPE=1
```

```
OK
```

The following #FTPPUT command configuration opens the data connection, and the module enters ONLINE mode. filename.txt is the file name where the data will be stored on the FTP server. If the file you are sending is a text file, the extension must be .txt.

```
AT#FTPPUT="filename.txt",0
```

```
CONNECT ← data connection is open.
```

... type in the data to write in the filename.txt file stored on the FTP server ...

```
+++ ← close the FTP data connection.
```

```
NOCARRIER
```

Close FTP control connection.

AT#FTPCLOSE

OK

← FTP control connection is closed.

Deactivate the PDP context.

AT#SGACT=1,0

OK

12.8.2. Data Uploading in COMMAND Mode

This example shows how to upload data toward an FTP server when the module is in COMMAND mode. A terminal emulator is connected to the module.

Before using #FTPOPEN command, the PDP context identified by <cid>=1, mandatorily assigned to the FTP Application, must be defined. Then <cid>=1 must be bound to a Multi-socket and activated through #SGACT command to create the related Network Interface. The #FTPOPEN command uses a Protocol Service Socket, but #SGACT command requires the PDP context bound to a Multi-socket.

Open the FTP connection toward the FTP server. The FTP server port is not specified; therefore, the command uses the default value 21. The FTP connection is in passive mode.

AT#FTPOPEN="server","username","password",1

OK

← FTP control connection open in passive mode.

The #FTPPUT command opens the data connection, and the module remains in COMMAND mode. filename.txt is the file name where the data will be stored on the FTP server.

AT#FTPPUT="filename.txt",1

OK

← data connection is open, the module is in COMMAND mode

Enter the #FTPAPPEXT command to upload data. After entering <CR>, the command returns the ">" prompt. Now, enter the data to be sent to the FTP server. As soon <bytestosend> bytes are written, data are sent to the FTP server, and the #FTPAPPEXT message is returned.

AT#FTPAPPEXT=bytestosend

>... type in data...

#FTPAPPEXT: <SentBytes>

OK

Use again the #FTPAPPEXT=bytestosend command to send a new data chunk.

To send the last data chunk and close the FTP connection, use the following:

AT#FTPAPPEXT=bytestosend,1

If a new file must be sent, repeat the sequence. If the file must be appended, use the AT#FTPAPP command (with <connMode> = 1).

NOTE: if while sending the chunks, the data connection is closed from remote side, user will be notified of it because #FTPAPPEXT command will return an error message, and the related cause (if +CMEE=2 is set). Data connection must be reopened with #FTPPUT command.

12.9. FTP Downloading

12.9.1. Downloading in ONLINE Mode

Assume that the FTP connection is open (control connection). Use the #FTPGET command to open a data connection and download a file from the FTP server. If the data connection succeeds, the command returns the CONNECT indication followed by the content of the file, at the end NO CARRIER indication is displayed. If no FTP control connection has been previously opened, the command returns an error message. Refer to example 12.11.1. The command syntax is:

AT#FTPGET = [<filename>]

To get parameters descriptions see documents [1], [2], [4], [11], [13], [14] or [15] according to the module used.

12.9.2. Downloading in COMMAND Mode

Assume that the FTP connection is open (control connection). Use the #FTPGETPKT command to open a data connection and download a file from the FTP server. If the data connection succeeds, the command stores the received data on the socket and returns the OK message. The module remains in COMMAND mode. If no FTP control connection has been previously opened, the command returns an error message. Refer to example 12.11.2. The command syntax is:

AT#FTPGETPKT=<filename>[,<viewMode>]

To get parameters descriptions see documents [1], [2], [4], [11], [13], [14] or [15] according to the module used.

After issuing #FTPGETPKT command, you can type in AT commands as usual in COMMAND mode, except for FTP commands that open data connection like #FTPLIST, because the data connection has been already opened by #FTPGETPKT itself.

When the data connection is open, use the `#FTPrecv?` read command to check how many buffered bytes are currently available.

With the `#FTPrecv=<blocksize>` command, you can transfer at most `<blocksize>` bytes onto the serial port. This number is limited to the current number of bytes of the remote file which have been transferred from the FTP server.

12.10. FTP Downloading Restart

To start an FTP downloading from a specific position (byte) of the file, use the `#FTPrest` command before typing in `#FTPGET` or `#FTPGETPKT` command. The command syntax is:

AT#FTPrest=<restartposition>

To get parameters descriptions see documents [1], [2], [4], [11], [13], [14] or [15] according to the module used.

NOTE: it is mandatory to issue `#FTPTYPE=0` command to set binary transfer type before entering `#FTPGET` or `#FTPGETPKT` command.

12.11. Examples

12.11.1. File Downloading in ONLINE Mode

Enable reports in verbose format.

AT+CMEE=2

OK

Assume that the PDP context `<cid>=1` has been bound to a socket by means of the `#SCFG` command. Now, define PDP context `<cid>=1`.

AT+CGDCONT=1,"IP", "Access_Point_Name"

OK

Activate the PDP Context. The command returns the IP address assigned by the network to the module.

AT#SGACT=1,1

#SGACT: 193.199.234.255

OK

Set the FTP time-out.

AT#FTPTO=1000

OK

Before using #FTPOPEN command, the PDP context identified by <cid>=1, mandatorily assigned to the FTP Application, must be defined. Then <cid>=1 must be bound to a Multi-socket and activated through #SGACT command to create the related Network Interface. The #FTPOPEN command uses a Protocol Service Socket, but #SGACT command requires the PDP context bound to a Multi-socket.

Open an FTP connection toward the FTP server. The FTP server port is not specified; therefore, the command uses the default value 21. The FTP connection is in active mode (default).

AT#FTPOPEN="server","username","password"

OK ← FTP control connection open, and in active mode.

Set the file type.

AT#FTPTYPE=0

OK

Check the working directory.

AT#FTPPWD

#FTPPWD: 257 "/"

OK

Use #FTPLIST command to get the list of files on the working directory of the FTP server.

Use the #FTPGET command to open e data connection and download a file from the FTP server.

AT#FTPGET="filename.txt"

CONNECT ← data connection is open.

... the content of the file appears on terminal emulator ...

NO CARRIER ← data connection is closed automatically when the downloading is terminated.

Close FTP control connection.

AT#FTPCLOSE

OK ← FTP control connection is closed.

Deactivate the PDP context.

AT#SGACT=1,0

OK

12.11.2. File Downloading in COMMAND Mode

Assume that the FTP connection is open. Use the #FTPGETPKT command to open a data connection and download a file from the FTP server. Data are buffered on the socket; the module remains in COMMAND mode.

AT#FTPGETPKT="filename.txt"

OK ← data connection is open.

The following command reports the number of bytes buffered on the socket.

AT#FTPRECV?

#FTPRECV: 600

OK

Read the first 400 bytes of the available buffered data.

AT#FTPRECV=400

#FTPRECV: 400

Text row number 1 * 111111111111111111111111111111111111 *

Text row number 2 * 222222222222222222222222222222222222 *

Text row number 3 * 333333333333333333333333333333333333 *

Text row number 4 * 444444444444444444444444444444444444 *

Text row number 5 * 555555555555555555555555555555555555 *

Text row number 6 * 666666666666666666666666666666666666 *

Text row number 7 * 777777777777777777777777777777777777 *

Text row number 8 * 888888888888888888888888888888888888

OK

Read 200 bytes – if available – starting from the position + 1 of the last byte read with the previous #FTPRECV command.

AT#FTPRECV =200

#FTPRECV: 200

88888 *

Text row number 9 * 999999999999999999999999999999999999 *

Text row number 10 * AAAAAAAAAAAAAAAAAAAAAAAAAAAAAAAAAA *

Text row number 11 * BBBBBBBBBBBBBBBBBBBBBBBBBBBBBBBBBB *

Text row number 12 * CCCCCCCCCCCCCCCC

OK

The #FTPGETPKT? read command reports the download state.

AT#FTPGETPKT?

#FTPGETPKT: filename.txt,0,1

OK

The first parameter is the file name, the second indicates text or hex mode. The third parameter indicates <EOF> (End of File): 0 file transfer is in progress; 1 file transfer is ended.

Data connection (data port) is automatically closed by the last AT#FTPGETPKT? read command when the whole file has been read.

A new FTP download in ONLINE or COMMAND mode can be started by issuing respectively #FTPGET or #FTPGETPKT command.

12.11.3. FTP and 4G Modules

As stated before, in 2G/3G modules the FTP Service uses the <cid>=1 (or <cid>=0). In 4G modules the <cid>=1 is used by the Default EPS Bearer created during the attach procedure. The 4G modules provide the #PROTOCOLCFG command which allows to configure the <cid> used by the FTP Service. This example shows a case in which the APN assigned by the network, during the attach procedure, does not support data traffic, therefore it is required to move the FTP service, for example, on <cid>=2.

Check if the module is registered on a 4G network.

AT+COPS?

+COPS: 1,0,"Network_Operator",7 ← 7 = E-UTRAN

OK

Enable ERROR report in verbose format.

AT+CMEE=2

OK

By default, the <cid>=1 context identifier is assigned to a not defined APN

AT+CGDCONT?

+CGDCONT: 1,"IPV4V6","","",0,0

OK

When the network recognizes the attach request with a not defined APN, the network assigns to <cid>=1 an APN supporting some services. The module is 4G attached.

AT+CGATT?

+CGATT: 1 ← the module is 4G attached

OK

After the Attach procedure, the <cid>=1 identifies the Default EPS Bearer assigned by the network, and it is already activated.



```

AT+CGACT?
+CGACT: 1,1
OK

```

```

AT+CGCONTRDP=?
+CGCONTRDP: (1)      ← <cid>=1 is associated to the active context.
OK

```

List the parameters regarding the Default EPS Bearer assigned by the network and associated to <cid>=1 context identifier.

```

AT+CGCONTRDP=
+CGCONTRDP:
1,
5,
"APN_Assigned_by_Network",
"10.178.0.31.255.0.0.0",
"10.178.0.32","213.230.129.10",
"0.0.0.0",
"0.0.0.0",
"0.0.0.0"

```

Check the <cid> value used for each protocol, default configuration.

```

AT#PROTOCOLCFG?
#PROTOCOLCFG: "FTP",1,0,0,0
#PROTOCOLCFG: "SMTP",1,0,0,0
#PROTOCOLCFG: "PING",1,0,0,0
#PROTOCOLCFG: "SSL",1,0,0,0
OK

```

The Default EPS Bearer identified by <cid>=1 is already active, contrary to what is indicated by the #SGACT command below. This means that a Network Interface has not been created.

```

AT#SGACT?
#SGACT: 1,0
OK

```

Try to open an FTP connection (control connection). The opening fails because the Network Interface has not been created.

```

AT#FTPOPEN="server","username","password"
+CME ERROR: Cannot resolve name

```

The <cid>=1 used by the following #SGACT command is already active. Its activation is the result of the default bearer context activation procedure part of the attach procedure.

The command below returns the IP address shown by the +CGCONTRDP= command and opens only a Network Interface.

```
AT#SGACT=1,1
#SGACT: 10.178.0.31
OK
```

Try to open the FTP connection. Now, the opening fails again because the APN assigned by the network on <cid>=1 does not support data traffic, see figure below.

```
AT#FTPOPEN="server","username","password"
+CME ERROR: Cannot connect control socket
```

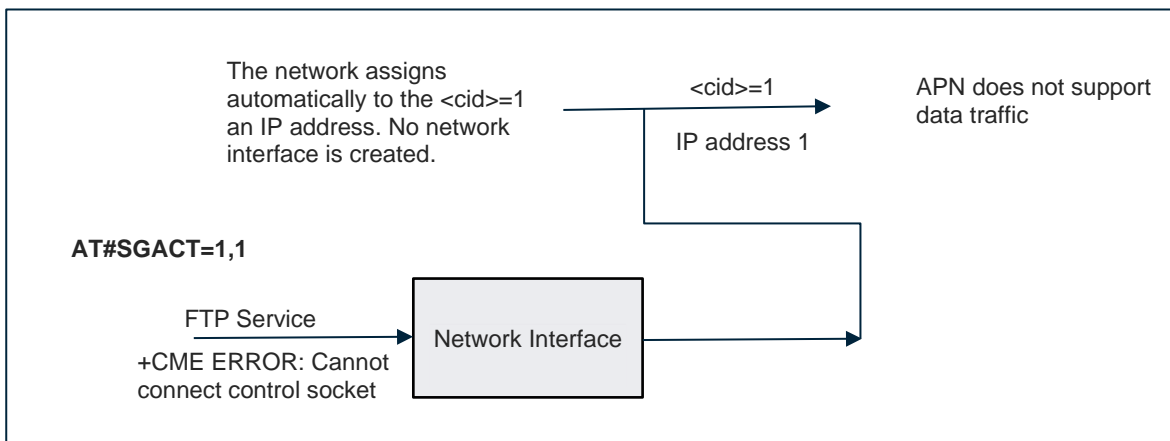

Figure 7: Assigned APN does not Support Data Traffic

It is required to change the <cid> used by the FTP Service and define a PDP context identified by the <cid> associated to the FTP Service.

```
AT#PROTOCOLCFG="FTP",2
OK
```

Verify the new configuration.

```
AT#PROTOCOLCFG?
#PROTOCOLCFG: "FTP",2,0,0,0
#PROTOCOLCFG: "SMTP",1,0,0,0
#PROTOCOLCFG: "PING",1,0,0,0
#PROTOCOLCFG: "SSL",1,0,0,0
OK
```

Define the PDP context identified by <cid>=2.

```
AT+CGDCONT=2,"IP","Access_Point_Name","0.0.0.0"
OK
```

```
AT+CGDCONT?
+CGDCONT: 1,"IPV4V6","","",0,0
+CGDCONT: 2,"IP","Access_Point_Name","0.0.0.0",0,0
```

OK

Activate PDP context <cid>=2 and create a Network Interface related to <cid>=2.

AT#SGACT=2,1

#SGACT: 2.192.17.237

OK

Check which contexts are active.

AT#SGACT?

#SGACT: 1,1

#SGACT: 2,1

OK

Open an FTP connection (control connection) toward the FTP server. The FTP server port is not specified; therefore, the command uses the default value 21. The FTP connection is in active mode (default), see Fig. 8.

AT#FTPOPEN="server","username","password"

OK ← FTP control connection open in active mode.

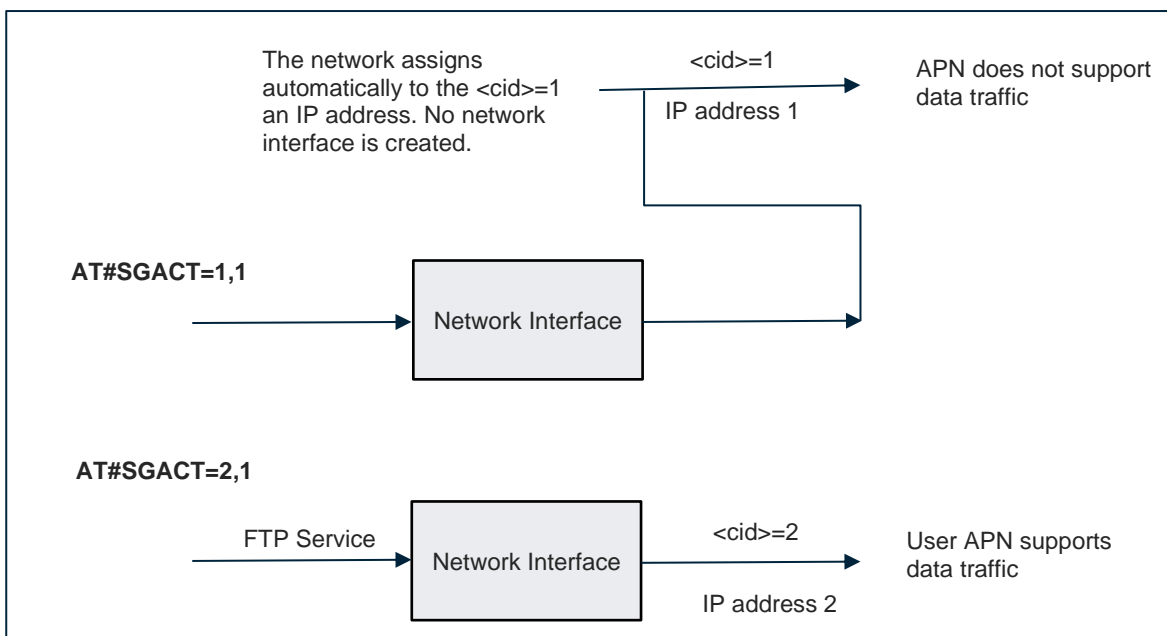

Figure 8: User APN Supports Data Traffic

Use the FTP Service as shown for 2G/3G modules.

13. MQTT PROTOCOL

MQTT is an OASIS standard lightweight, publish-subscribe network protocol for the Internet of Things (IoT).

You can use #MQEN command that initializes MQTT client, #MQCFG command that configures Broker URL and port and #MQCONN command that establishes the socket and connects to the broker to open a connection.

You can initialize and connect up to two MQTT client instances simultaneously.

13.1. MQTT Client Initialization, #MQEN Command

Use #MQEN command to enable/disable one of the two instance provided by modules, to initialize an MQTT client. The instance are identified by the <instanceNumber> parameter. If the request succeeds, the #MQEN command returns the OK message, otherwise an error code is reported.

AT#MQEN=<instanceNumber>,<enable>

If you try to initialize an instance which is already enabled, command returns error. Give value <enable> = 0 to disable the client, 1 to enable it.

The AT#MQEN=? test command returns the supported range of parameters value. Example: <instanceNumber> range: 1-2, <enable> range: 0-1

AT#MQEN=?

#MQEN: (1-maxClients),(0-1)

OK

The AT#MQEN? read command returns the current state for each instance in the following format:

#MQEN: <instanceNumber>,<enabled>

Example:

AT#MQEN?

#MQEN: 1,1

#MQEN: 2,0

OK

13.2. MQTT Client Configuration Commands

MQTT configurations can be performed after enabling the MQTT client. Before establishing the connection using #MQCONN command, it is mandatory to provide connection configurations using #MQCFG commands. You can use other config commands if required. Use the following commands to set the configurations:

13.2.1. #MQCFG Command

Use this command to provide following configurations for the instance identified by the <instanceNumber> parameter:

- a. IP address/URL of the MQTT Broker
- b. Port Number of the MQTT Broker
- c. PDP cid enable by #SGACT at command. Connection will be handled by PDP cid configured here. PDP should be enabled before giving this command.
- d. SSL (Secured connection) is required or not

The command syntax is:

AT#MQCFG=<instanceNumber>,<hostname>,<port>,<cid>[,<sslEn>]

Refer to example 13.4.1



PDP context should be enabled before giving this command.

Default value of <cid> = 0.

To get parameters descriptions see documents [14] or [15] according to the module used.

The AT#MQCFG? read command returns the configuration for each instance in the following format:

#MQCFG: <instanceNumber>,<hostname>,<port>,<cid>[,<sslEn>]

Default parameters are:

AT#MQCFG?

#MQCFG: 1,,1883,1,0

#MQCFG: 2,,1883,1,0

OK

13.2.2. #MQCFG2 Command

Use this command to provide following additional configurations for the instance identified by the <instanceNumber> parameter:

- a. Keep Alive duration in seconds
- b. Clean session is required or not

The command syntax is:

AT#MQCFG2=<instanceNumber>,<keepAlive>,<cleanSession>

Refer to example 13.4.1

To get parameters descriptions see documents [14] or [15] according to the module used.

The AT#MQCFG2? read command returns the configuration for each instance in the following format:

#MQCFG2: <instanceNumber>,<keepAlive>,<cleanSession>

Default parameters are:

AT#MQCFG2?

#MQCFG2: 1,20,1

#MQCFG2: 2,20,1

OK

13.2.3. #MQWCFG Command

Use this command to provide following Last Will and testament related configurations for the instance identified by the <instanceNumber> parameter:

- a. Whether the client needs to specify a Last
- b. If client needs to specify last will, also specify last will retain, QoS, topic and message

The command syntax is:

AT#MQWCFG=<instanceNumber>,<willFlag>[,<willRetain>,<willQos>,<willTopic>,<willMsg>]

Refer to example 13.4.1

To get parameters descriptions see documents [14] or [15] according to the module used.

The AT#MQWCFG? read command returns the configuration for each instance in the following format:

#MQWCFG:<instanceNumber>,<willFlag>[,<willRetain>,<willQos>,<willTopic>,<willMsg>]

Default parameters are:

AT#MQWCFG?

#MQWCFG: 1,0

#MQWCFG: 2,0

OK

13.2.4. #MQTCFG Command

Use this command to provide packet timeout in seconds for the instance identified by the <instanceNumber> parameter.

The command syntax is:

AT#MQTCFG=<instanceNumber>,<pktTimeout>

Refer to example 13.4.1

To get parameters descriptions see documents [14] or [15] according to the module used.

The AT#MQTCFG? read command returns the configuration for each instance in the following format:

#MQTCFG: <instanceNumber>,<pktTimeout>

Default parameters are:

AT#MQTCFG?

#MQTCFG: 1,10

#MQTCFG: 2,10

OK

13.3. MQTT Client Connection Commands

13.3.1. #MQCONN Command

Use #MQCONN command to connect the client to the broker specified in #MQCFG command. Instance is identified by the <instanceNumber> parameter.

The command syntax is:

AT#MQCONN=<instanceNumber>,<clientId>,<userName>,<passWord>

Refer to example 13.4.1

To get parameters descriptions see documents [14] or [15] according to the module used.

The AT#MQCONN? read command returns the status of each instance in the following format:

#MQCONN=<instanceNumber>,<state>

To get more details on MQTT client states, see documents [14] or [15] according to the module used.

Default parameters are:

AT#MQCONN?

#MQCONN: 1,0

#MQCONN: 2,0

OK

13.3.2. #MQDISC Command

Use #MQDISC command to disconnect the client to the broker. Instance is identified by the <instanceNumber> parameter.

The command syntax is:

AT#MQDISC=<instanceNumber>

Refer to example 13.4.1

To get parameters descriptions see documents [14] or [15] according to the module used.

13.4. Example

13.4.1. MQTT Client Connection Unsecured

This example shows the establishing an unsecured MQTT connection.

Enable reports in verbose format.

```
AT+CMEE=2
```

```
OK
```

Check PDP contexts.

```
AT+CGDCONT?
```

```
OK
```

← no PDP context are defined.

Define PDP context <cid>=1.

```
AT+CGDCONT=1,"IP", "Access_Point_Name"
```

```
OK
```

Check PDP contexts.

```
AT+CGDCONT?
```

```
+CGDCONT: 1,"IP", "Access_Point_Name", "0.0.0.0", 0,0
```

```
OK
```

Activate PDP context <cid>=1. The command returns the IP address assigned by the network to the module.

```
AT#SGACT=1,1
```

```
#SGACT: 37.176.124.199
```

```
OK
```

Enable MQTT client.

```
AT#MQEN=1,1
```

```
OK
```

Check MQTT client state

```
AT#MQEN?
```

```
#MQEN: 1,1 ← Instance 1 is enable.
```

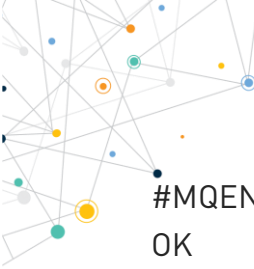

#MQEN: 2,0
OK

Configure server URL, Port number and PDP cid initialized before.

AT#MQCFG=1,"mqtt_broker_address",mqtt_broker_port,1
OK

Provide other MQTT configurations if required.

AT#MQCFG2=1,60,1
OK

AT#MQTCFG=1,30
OK

AT#MQWCFG=1,1,1,1,"will_topic","will_message"
OK

Open the MQTT connection. Provide client id, username and password. If username and password are not required enter empty strings

AT#MQCONN=1,"client_id","", ""
OK

Check the MQTT client status.

AT#MQCONN?
#MQCONN: 1,1
OK

← Instance 1 is in connected state.

.. Perform MQTT operations ..

Disconnect the MQTT client

AT#MQDISC=1
OK

Check the MQTT client status

AT#MQCONN?
#MQCONN: 1,0
OK

← Instance 1 is in disconnected state.

Disable MQTT client

AT#MQEN=1,0

OK

Check MQTT client state

AT#MQEN?

#MQEN: 1,0

← Instance 1 is disabled.

#MQEN: 2,0

OK

13.5. MQTT Operations - Publish, Subscribe and Unsubscribe Commands

MQTT Operations – Publish, Subscribe and Unsubscribe can be performed after connecting the MQTT client.

13.5.1. #MQPUBS Command

Use this command to publish MQTT message to the broker connected. If operation is successful, OK is reported. In case of QoS greater than 0, it is successful if required acknowledgement is received.

The command syntax is:

AT#MQPUBS=<instanceNumber>,<topic>,<retain>,<qos>,<message>

Refer to example 13.7.1.

To get parameters descriptions see documents [14] or [15] according to the module used.

13.5.2. #MQSUB Command

Use this command to subscribe to a topic. It send subscribe message to the broker connected and receives the response. If operation is successful, OK is reported. The instance of the client publishing message is identified by the <instanceNumber> parameter.

The command syntax is:

AT#MQSUB=<instanceNumber>,<topic>

Refer to example 13.7.1.

To get parameters descriptions see documents [14] or [15] according to the module used.

13.5.3. #MQUNS Command

Use this command to revoke subscription of a topic. It send unsubscribe message to the broker connected and receives the response. If operation is successful, OK is reported. The instance of the client publishing message is identified by the <instanceNumber> parameter.

The command syntax is:

AT#MQUNS=<instanceNumber>,<topic>

Refer to example 13.7.1.

To get parameters descriptions see documents [14] or [15] according to the module used.

13.6. MQTT Publish Read

13.6.1. #MQRING URC

Whenever client receives a publish message on a subscribed topic, user is notified through #MQRING URC on all AT commands interfaces. There are 30 messages slots available for incoming messages, and it is responsibility of the user to keep them empty by reading them with #MQREAD

Syntax of the URC is:

#MQRING: <instanceNumber>,<mId>,<topic>,<len>

If the queue is full, URC received is;

#MQRING: 0

13.6.2. #MQREAD Command

Use this command to command reads the message payload from the queue slot provided. You have to provide instance number of the client on which the message is received and message id of the message to read. Message id (<mld>) was specified in the #MQRING URC.

The command syntax is:

AT#MQREAD=<instanceNumber>,<mld>

Refer to example 2.7.1.

To get parameters descriptions see documents [14] or [15] according to the module used.

The AT#MQREAD? read command returns the number of messages received for each active instance in the following format:

#MQCFG2: <instanceNumber>,<keepAlive>,<cleanSession>

Default parameters are:

AT#MQREAD?

#MQREAD: 1,0

#MQREAD: 2,0

OK

13.7. Example

13.7.1. Publish, Subscribe and Unsubscribe Operations

This example shows establishing:

- a. Establishin plain MQTT connection,
- b. Subscribing a topic “test”, publishing on the same and receiving the message on the same.
- c. Unsubscribing the topic “test”
- d. Subscribing on another topic “test/light” and receiving messages on the same.
- e. Subscribing on wildcard topic “test/fan/#” and receiving messages on the same.

Enable reports in verbose format.

AT+CMEE=2

OK

Check PDP contexts.

AT+CGDCONT?

OK

← no PDP context are defined.

Define PDP context <cid>=1.

AT+CGDCONT=1,"IP", "Access_Point_Name"

OK

Check PDP contexts.

AT+CGDCONT?

+CGDCONT: 1,"IP","Access_Point_Name","0.0.0.0",0,0

OK

Activate PDP context <cid>=1. The command returns the IP address assigned by the network to the module.

AT#SGACT=1,1

#SGACT: 37.176.124.199

OK

Enable MQTT client.

AT#MQEN=1,1

OK

Check MQTT client state

AT#MQEN?

#MQEN: 1,1

#MQEN: 2,0

OK

← Instance 1 is enabled.

Configure server URL, Port number and PDP cid initialized before.

AT#MQCFG=1,"mqtt_broker_address",mqtt_broker_port,1

OK

Provide other MQTT configurations if required.

AT#MQCFG2=1,60,1

OK

AT#MQTCFG=1,30



OK

AT#MQWCFG=1,1,1,1,"will_topic","will_message"

OK

Open the MQTT connection. Provide client id, username and password.

AT#MQCONN=1,"client_id","username","password"

OK

Check the MQTT client status.

AT#MQCONN?

#MQCONN: 1,1

← Instance 1 is in connected state.

OK

Subscribe to the topic "test"

AT#MQSUB=1,"test"

OK

Publish message on the topic "test"

AT#MQPUBS=1,"test",0,1,"message"

OK

#MQRING: 1,1,test,7 ← #MQRING URC received for client instance 1, topic "test".

Read the message notified by the URC #MQRING.

AT#MQREAD=1,1

#MQREAD: 1,test,7

<<<

message

OK

Unsubscribe to the topic "test"

AT#MQUNS=1,test

OK

Subscribe to the topic "test/light"

AT#MQSUB=1,"test/light"

OK

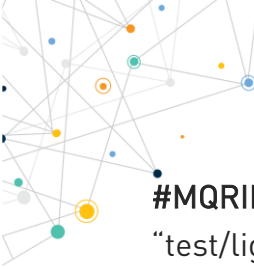

#MQRING: 1,1,test/light,3 ← #MQRING URC received for client instance 1, topic “test/light”.

Read the message notified by the URC #MQRING.

AT#MQREAD=1,1

#MQREAD: 1,test/light,3

<<<

OFF

OK

Subscribe to the wildcard topic “test/fan/#”

AT#MQSUB=1," test/fan/#"

OK

#MQRING: 1,1, test/fan/floor1,3 ← #MQRING URC received for client instance 1, topic “test/fan/floor1”.

#MQRING: 1,2, test/fan/floor4,2 ← #MQRING URC received for client instance 1, topic “test/fan/floor4”.

Read the message notified by the URC #MQRING.

AT#MQREAD=1,1

#MQREAD: 1, test/fan/floor1,3

<<<

OFF

OK

AT#MQREAD=1,2

#MQREAD: 1, test/fan/floor4,2

<<<

ON

OK

14. PING PROTOCOL

Ping protocol is used to measure the round-trip time for messages sent by the module to the remote host that are echoed back to the sender.

14.1. 2G/3G Modules

The PING connection can use only the PDP context identified by <cid>=1, or the GSM context identified by <cid>=0. The PING command uses one of the two contexts according to the command previously entered: AT#SGACT=1,1 or AT#SGACT =0,1 respectively.

Referring to the example shown in Tab. 22:

- PING Service socket bound to <cid>=1 (mandatory)
- Sockets <connId>= 1, 2, 3 not opened, and bound to active <cid>=1
- Sockets <connId>= 4, 5, 6 not opened, and bound to active <cid>=3

IP Easy Multi-Socket <connId>	<cid>=1 Active	<cid>=2 No active	<cid>=3 Active	<cid>=4 No active	<cid>=5 No active
1	bound	/	/	/	/
2	bound	/	/	/	/
3	bound	/	/	/	/
4	/	/	bound	/	/
5	/	/	bound	/	/
6	/	/	bound	/	/
Protocol Service Sockets					
PING	bound				

Tab. 22: 2G/3G Multi-Socket & PING Service Socket

Use #PING command to send ICMP Echo Request packets to the specified host and wait for an ICMP Echo Reply. The command syntax is:

AT#PING=<IPAddr>[,<retryNum>[,<len>[,<timeout>[,<tTl>]]]]

Echo Replay message format:

#PING: <replyId>,<IP Address>,<replyTime>,<tTl>

Use #ICMP command to enable ICMP Echo Replay. The command syntax is:

AT#ICMP=<mode>

To get parameters descriptions see documents [1], or [2], according to the module used.

Example

It is not mandatory to use #ICMP before #PING to receive the ICMP Echo Replay.

Check ICMP Ping support.

AT#ICMP?

#ICMP: 0 ← support disabled (default)

OK

Define PDP context <cid>=1.

AT+CGDCONT=1,"IP","Access_Point_Name"

OK

Activate the PDP context <cid>=1. The command returns the IP address assigned by the network to the module.

AT#SGACT=1,1

#SGACT: 10.160.118.113

OK

Before using #PING command, the PDP context identified by <cid>=1, mandatorily assigned to the PING Application, must be defined. Then <cid>=1 must be bound to a Multi-socket and activated through #SGACT command to create the related Network Interface. The #PING command uses a Protocol Service Socket, but #SGACT command requires the PDP context bound to a Multi-socket.

Ping the Primary Google DNS.

AT#PING="8.8.8.8"

#PING: 01,"8.8.8.8",600,255

#PING: 02,"8.8.8.8",5,55

#PING: 03,"8.8.8.8",5,55

#PING: 04,"8.8.8.8",3,55

OK

14.2. 4G Modules

The SMTP Use #PING command to send ICMP Echo Request packets to the specified host and wait for an ICMP Echo Reply. The command syntax is:

AT#PING=<IPAddr>[,<retryNum>[,<len>[,<timeout>[,<tTl>]]]]

Echo Replay message format:



#PING: <replyId>,<IP Address>,<replyTime>,<tTl>

Use #ICMP command to enable ICMP Echo Replay. The command syntax is:

AT#ICMP=<mode>

To get parameters descriptions see documents [4], [11], [13], [14] or [15] according to the module used.

Platforms ID 20 and 25 provide the #PROTOCOLCFG command to configure which <cid> the PING Application can use, in accordance with the ISP requirements. In addition, the <cid> range can vary according to the 4G product you are using. Refer to chapter 9.2.1 (#PROTOCOLCFG) to change the <cid> identifier bound to PING Application.

To get parameters descriptions see documents [4] or [13] according to the module used.

For platform Version ID 30, 37

AT#PING=<IPAddr>[,<retryNum>[,<len>[,<timeout>[,<tTl>[,<pdId>]]]]]

To get parameters descriptions, refer to documents [14] or [15] according to the module used.

15. EASY GSM: IP OVER CSD

In the Easy GSM configuration, the user device, connected by a serial line to the Telit module, exchanges data, over a GSM CSD call, with a remote device on Internet network, refer to Fig. 9.

Telit module establishes a GSM CSD call, and exchanges TCP/IP packets, encapsulated in the PPP protocol, with the remote device. The data are sent as if it were a voice signal, the CSD call occupies the radio channels during the entire duration of the connection, regardless of whether data are transmitted or not. The user device does not need an own TCP/IP stack.

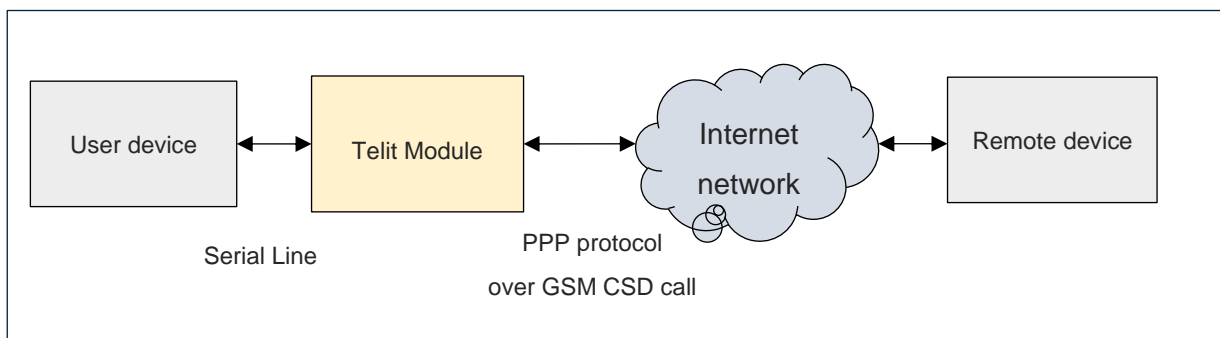

Figure 9: GSM CSD Call

GSM CSD call supports #SD command (IP Easy Environment), HTTP, SMTP, FTP, and PING connections. To establish a GSM CSD call, must be defined and activated the GSM context identified by <cid>= 0.

This section describes the AT commands to configure and activate the GSM context used to establish a GSM CSD call. For information on outgoing and incoming connections, refer respectively to chapter 6, and chapter 7. There are no differences at socket level.

Here are the AT commands to define, bind, and activate the GSM context type.

- AT#GSMCONT to configure the GSM context identified by <cid> = 0
- AT#SCFG to bind the GSM context to a socket belonging to the Multi-socket environment
- AT#SGACT to activate the GSM Context

15.1. GSM Context Setting

In the The GSM context is configured by the #GSMCONT command, its syntax is:

AT#GSMCONT=<cid>[,<P_type>, <CSD_num>]

To get parameters descriptions see documents [1] or [2], according to the module used.



4G modules (ID 20, 23, 25, 30, 37) do not support AT#GSMCONT command.

15.2. GSM Context Activation

GSM context type is activated through the #SGACT command using <cid> = 0. The activation may require the authentication parameters (Username and Password), depending on the Internet Service Provider. The command syntax is the same used for PDP context type.

AT#SGACT= 0,<stat>[,<userID>,<pwd>]

NOTES

- I. When the GSM context is active, PDP contexts are not allowed because Telit modules work in Class B. Therefore, if a GSM CSD call is on, no GPRS operation is allowed, see example in chapter 14.3.1.
- II. GSM context activation is affected by the +CBST command, like all CSD calls. The maximum data rate that can be set through +CBST command is 14400 bps (network dependent). Context activation is just allowed in "NON-TRANSPARENT" mode by default.
- III. The +COPS=? and #CSURV commands return an error message if a data call is active. Therefore, they return an error message also if a GSM context is active; see example 14.3.2.

15.3. Examples

15.3.1. GSM/PDP Contexts & FTP Protocol

This example shows that when the GSM context (<cid>=0) is activated, it is not allowed to use PDP contexts. To show this, the example tries to open two socket connections, and a FTP connection.

Enable error report in verbose format.

AT+CMEE=2

OK

Check the sockets/PDP contexts binding configuration (default).

AT#SCFG?

#SCFG: 1,1,300,90,600,50

#SCFG: 2,1,300,90,600,50

#SCFG: 3,1,300,90,600,50

#SCFG: 4,2,300,90,600,50

#SCFG: 5,2,300,90,600,50

#SCFG: 6,2,300,90,600,50

OK

Assume that the PDP contexts have been set as shown below.

AT+CGDCONT?

+CGDCONT: 3,"IP","Access_Point_Name","0.0.0.0",0,0

+CGDCONT: 4,"IP","Access_Point_Name","0.0.0.0",0,0

OK

Activate PDP context <cid>=3. The command returns an error message because the PDP context is not bound to any sockets. The binding is mandatory.

AT#SGACT=3,1

+CME ERROR: operation not supported

Before activating PDP contexts <cid>=3 and <cid>=4, bind them respectively to the socket <connId>=1 and <connId>=5.

AT#SCFG = 1, 3, 300, 90, 600, 50

OK

AT#SCFG = 5, 4, 300, 90, 600, 50

OK

Check the new sockets/PDP contexts binding configuration.

AT#SCFG?

#SCFG: 1,3,300,90,600,50

#SCFG: 2,1,300,90,600,50

#SCFG: 3,1,300,90,600,50

#SCFG: 4,2,300,90,600,50

#SCFG: 5,4,300,90,600,50

#SCFG: 6,2,300,90,600,50

OK

Define GSM context <cid>=0.

AT#GSMCONT=0,"IP","ISP_phone_number"

OK

Check GSM context.



```
AT#GSMCONT?  
#GSMCONT: 0,"IP","ISP_phone_number"  
OK
```

Activate GSM context <cid>=0. The command returns an error message because the GSM context is not bound to any sockets. The binding is mandatory.

```
AT#SGACT=0,1  
+CME ERROR: operation not supported
```

Before activating GSM context <cid>=0 bind it to the socket 3.

```
AT#SCFG = 3, 0, 300, 90, 600, 50  
OK
```

Check the new sockets/contexts binding configuration.

```
AT#SCFG?  
#SCFG: 1,3,300,90,600,50  
#SCFG: 2,1,300,90,600,50  
#SCFG: 3,0,300,90,600,50  
#SCFG: 4,2,300,90,600,50  
#SCFG: 5,4,300,90,600,50  
#SCFG: 6,2,300,90,600,50  
OK
```

If PDP contexts are activated before the activation of the GSM context, no error message is returned by the #SGACT.

```
AT#SGACT = 3,1                    ← activate the PDP context 3  
#SGACT: 109.112.140.34  
OK
```

```
AT#SGACT = 4,1                    ← activate the PDP context 4  
#SGACT: 37.159.24.75  
OK
```

```
AT#SGACT = 0,1                   ← activate the GSM context 0  
#SGACT: 10.141.94.204  
OK
```

Check which contexts are active.

```
AT#SGACT?  
#SGACT: 0,1  
#SGACT: 3,1  
#SGACT: 4,1  
OK
```

Make sure that the server is in listening mode and try to open the socket connection <connId>=1 toward it, the command returns an error message.

```
AT#SD=1,0,1024,"server_address"
```

```
+CME ERROR: timeout in opening socket
```

Try to open the socket connection <connId>=5, the command returns an error message.

```
AT#SD=5,0,1024,"server_address"
```

```
+CME ERROR: timeout in opening socket
```

Try to open an FTP control connection toward an FTP server. The #FTOPEN command uses the GSM context; refer to chapter 15. The connection works.

```
AT#FTPOPEN="server","username","password"
```

```
OK ← FTP control connection is open, and in active mode.
```

To open successfully a socket connection (in this example <connId>=1, or <connId>=5) you must close the FTP connection and deactivate the GSM context.

Close the FTP connection.

```
AT#FTPCLOSE
```

```
OK
```

Deactivate the GSM context.

```
AT#SGACT=0,0
```

```
OK
```

```
AT#SGACT?
```

```
#SGACT: 0,0
```

```
#SGACT: 3,1
```

```
#SGACT: 4,1
```

```
OK
```

For example, open the socket connection 5.

```
AT#SD=5,0,1024,"server_address"
```

```
CONNECT ← the socket connection works.
```

15.3.2. GSM Context & +COPS=? Command

Enable error report in verbose format.

```
AT+CMEE=2
```

```
OK
```

Check the current sockets/PDP contexts binding configuration (default).

```
AT#SCFG?
```

```
#SCFG: 1,1,300,90,600,50
```

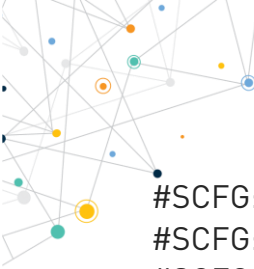

```
#SCFG: 2,1,300,90,600,50
#SCFG: 3,1,300,90,600,50
#SCFG: 4,2,300,90,600,50
#SCFG: 5,2,300,90,600,50
#SCFG: 6,2,300,90,600,50
OK
```

Before activating GSM context (<cid>=0) bind it to the socket 3.

```
AT#SCFG = 3, 0, 300, 90, 600, 50
OK
```

Check the new sockets/PDP contexts binding configuration.

```
AT#SCFG?
#SCFG: 1,1,300,90,600,50
#SCFG: 2,1,300,90,600,50
#SCFG: 3,0,300,90,600,50
#SCFG: 4,2,300,90,600,50
#SCFG: 5,2,300,90,600,50
#SCFG: 6,2,300,90,600,50
OK
```

Define GSM context.

```
AT#GSMCONT=0,"IP","ISP_phone_number"
OK
```

Check GSM context.

```
AT#GSMCONT?
#GSMCONT: 0,"IP","ISP_phone_number"
OK
```

AT+COPS=? test command returns information about the operators present on the network.

```
AT+COPS=?
+COPS: .....
OK
```

Now, activate the GSM context.

```
AT#SGACT = 0,1
#SGACT: 10.141.94.204
OK
```

Type in again AT+COPS=? test command. In this case, it returns an error message.

```
AT+COPS=?
+CME ERROR: no network service
```

15.3.3. HTTP Client with #SD

This example describes how establish a CSD call, create an HTTP connection toward an HTTP server, and retrieves an HTML page using a socket dial connection (#SD). The socket connection is running over the CSD call. A terminal emulator is connected to the module. See also the example 10.4.4, just for comparison.

Define GSM context.

```
AT#GSMCONT = 0,"IP","ISP_phone_number"  
OK
```

Before activating GSM context (<cid>=0) bind it to the socket 6.

```
AT#SCFG = 6, 0, 300, 90, 600, 50  
OK
```

Check the sockets/contexts binding configuration.

```
AT#SCFG?  
#SCFG: 1,1,300,90,600,50  
#SCFG: 2,1,300,90,600,50  
#SCFG: 3,1,300,90,600,50  
#SCFG: 4,2,300,90,600,50  
#SCFG: 5,2,300,90,600,50  
#SCFG: 6,0,300,90,600,50  
OK
```

Activate the GSM context, and assume that no UserID and Password are needed. The command returns the IP address assigned by the network.

```
AT#SGACT=0,1  
#SGACT: 10.137.93.60  
OK
```

Open the connection toward the HTTP server on port=80. Transport protocol is TCP.

```
AT#SD=6,0,80,"HTTP_server_address",0,0  
CONNECT ← the connection is open. The module is in ONLINE mode.
```

Now, following the HTTP protocol, ask the homepage by sending the next lines to the module. The entered data are sent directly to the HTTP server. The strings sent to the HTTP server must be ended by line feed character. To see the issued commands, enable the local echo on terminal emulator.

```
GET / HTTP/1.1<cr><lf>
Host: www.xxxx.com<cr><lf>
Connection: keep-alive<cr><lf>
<cr><lf>
```

The HTTP server replies with the HTML code of the homepage and some debugging responses.

```
HTTP/1.1 200 OK
Date: Thu, 06 2003 10:21:58 GMT
Server: Apache/1.3.27 (Unix)
Last-Modified: Thu, 06 2003 10:21:58 GMT
Content-Type: text/html
Connection: close
```

```
<!DOCTYPE HTML PUBLIC "-//W3C//DTD HTML 3.2 FINAL//EN">
<HTML>
... here is all the HTML code of the page ...
</HTML>
```

+++ ← type in the escape sequence to suspend the connection.

OK ← the module is in COMMAND mode.

AT#SH=6

OK ← the connection is closed; the GSM context is still active.

15.3.4. FTP File Uploading

This example describes how to establish a CSD call, create a FTP connection toward a FTP server, and upload a file. The FTP connection is running over the CSD call. A terminal emulator is connected to the module.

Check the socket configuration (default).

AT#SCFG?

#SCFG: 1,1,300,90,600,50

#SCFG: 2,1,300,90,600,50

#SCFG: 3,1,300,90,600,50

#SCFG: 4,2,300,90,600,50

#SCFG: 5,2,300,90,600,50

#SCFG: 6,2,300,90,600,50

OK

Check that no PDP contexts are defined.

AT+CGDCONT?

OK

Bind socket <connId>=4 to GSM context.

AT#SCFG = 4,0,300, 90, 600, 50

OK

Check the new configuration

AT#SCFG?

#SCFG: 1,1,300,90,600,50

#SCFG: 2,1,300,90,600,50

#SCFG: 3,1,300,90,600,50

#SCFG: 4,0,300,90,600,50

#SCFG: 5,2,300,90,600,50

#SCFG: 6,2,300,90,600,50

OK

Define the GSM context.

AT#GSMCONT=0,"IP", "ISP_phone_number"

OK

AT#GSMCONT?

#GSMCONT: 0,"IP", "ISP_phone_number"

OK

Activate the GSM context. The command returns the IP address assigned by the network to the module.

AT#SGACT=0,1

#SGACT: 10.137.93.60

OK

Set FTP time out

AT#FTPTO=1000

OK

Open an FTP control connection toward the FTP server in active mode. The FTP server port is not specified; therefore, the command uses the default value 21.

AT#FTPOPEN="server","username","password"

OK ← FTP control connection is open.

AT#FTPTYPE=1 ← set ASCII file type.

OK

The following command opens the data connection, and the module enters ONLINE mode. filename.txt is the file name where the data will be stored on the FTP server.

AT#FTPPUT="filename.txt"

CONNECT ← the data connection is open.

... type in the data to write in the filename.txt file stored on the FTP server ...

+++ ← close the data connection.

NOCARRIER ← the module is in COMMAND mode.

AT#FTPCLOSE ← close FTP control connection.

OK

AT#SGACT=0,0 ← deactivate GSM context

OK

15.3.5. E-mail with no Attachment

This example describes how to establish a CSD call, create a SMTP connection, and send an e-mail.

Before activating GSM context (<cid>=0), for example, bind it to the socket 6.

AT#SCFG = 6, 0, 300, 90, 600, 50

OK

Check the sockets/contexts binding configuration.

AT#SCFG?

#SCFG: 1,1,300,90,600,50

#SCFG: 2,1,300,90,600,50

#SCFG: 3,1,300,90,600,50

#SCFG: 4,2,300,90,600,50

#SCFG: 5,2,300,90,600,50

#SCFG: 6,0,300,90,600,50

OK

Define GSM context.

AT#GSMCONT = 0,"IP", "ISP_phone_number"

OK

Activate the GSM context, and assume that no UserID and Password are needed. The command returns the IP address assigned by the network.

AT#SGACT=0,1



```
#SGACT: 10.137.93.60
OK
```

Set the SMTP connection parameters.

```
AT#SMTPCFG=1,587,1
OK
```

```
AT#ESMTP="SMTP_server_address" ← configure the SMTP server address of the
sender.
```

```
OK
```

```
AT#EADDR="sender_address" ← configure e-mail address of the sender.
```

```
OK
```

```
AT#EUSER="sender_user_name" ← configure username of the sender.
```

```
OK
```

```
AT#EPASSW="sender_user_password" ← configure user password of the sender.
```

```
OK
```

Send the e-mail with no attachment to the recipient having recipient_address.

```
AT#EMAILD="recipient_address","mail with no attachment"
```

```
> Hello<Ctrl-Z>
```

```
OK ← text of the e-mail has been sent successfully.
```

15.3.6. Modules in Server and Client Configuration

This example describes a remote connection between two modules. The first one is configured as a server that opens a socket connection in listen mode. The second one is configured as a client, it establishes a CSD call and opens a connection using the #SD command - over the CSD call - toward the server. Each module is connected to a terminal emulator. See also the example described in chapter 7.5.1, just for comparison.

Server Side

Check the sockets/PDP contexts binding configuration (default).

```
AT#SCFG?
```

```
#SCFG: 1,1,300,90,600,50
```

```
#SCFG: 2,1,300,90,600,50
```

```
#SCFG: 3,1,300,90,600,50
```

```
#SCFG: 4,2,300,90,600,50
```

```
#SCFG: 5,2,300,90,600,50
```



```
#SCFG: 6,2,300,90,600,50
```

```
OK
```

Only PDP context <cid>=1 has been set, all other contexts have been removed.

```
AT+CGDCONT?
```

```
+CGDCONT: 1,"IP","Access_Point_Nam ","0.0.0.0",0,0
```

```
OK
```

Activate the PDP context <cid>=1, and no UserID and Password are needed. The command returns the IP address assigned by the network. The client, to open the connection, will use this IP address. See client-side chapter.

```
AT#SGACT=1,1
```

```
#SGACT: 2.192.8.30
```

```
OK
```

Define an ACCEPT firewall chain to accept IP address of the client. See client side.

```
AT#FRWL=1," 10.141.94.204","0.0.0.0"
```

```
OK
```

Open <connId>=2 socket in listening mode on <port>=1024. The client will use this port.

```
AT#SL=2,1,1024
```

```
OK
```

When the client opens the connection, the server displays on the terminal emulator a SRING unsolicited indication with <connId>=2.

```
SRING: 2
```

Enter the following command to accept the connection 2.

```
AT#SA=2
```

```
CONNECT
```

```
... exchange data...
```

```
NO CARRIER
```

← on the client side has been entered #SH command, the connection is closed.

Client Side

Check the sockets/PDP contexts binding configuration (default configuration)

```
AT#SCFG?
```

```
#SCFG: 1,1,300,90,600,50
```

```
#SCFG: 2,1,300,90,600,50
```

```
#SCFG: 3,1,300,90,600,50
```

```
#SCFG: 4,2,300,90,600,50
```

```
#SCFG: 5,2,300,90,600,50
```

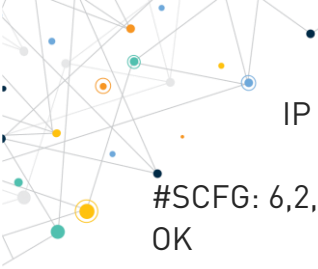

```
#SCFG: 6,2,300,90,600,50
OK
```

Before activating GSM context (<cid>=0) bind it to the socket 6.

```
AT#SCFG = 6, 0, 300, 90, 600, 50
OK
```

Check the new configuration

```
AT#SCFG?
#SCFG: 1,1,300,90,600,50
#SCFG: 2,1,300,90,600,50
#SCFG: 3,1,300,90,600,50
#SCFG: 4,2,300,90,600,50
#SCFG: 5,2,300,90,600,50
#SCFG: 6,0,300,90,600,50
OK
```

Define GSM Context (<cid>=0)

```
AT+CGDCONT=0,"IP","ISP_phone_number"
OK
```

Check GSM context.

```
AT#GSMCONT?
#GSMCONT: 0,"IP","ISP_phone_number"
OK
```

Activate the GSM Context, no UserID and Password are needed. The command returns the IP address assigned by the network to the module. The server will use this IP address to set its firewall. See server side.

```
AT#SGACT=0,1
#SGACT: 10.141.94.204
OK
```

Open the connection toward the server using its IP address and port 1024, see sever side.

```
AT#SD=6,0,1024,"2.192.8.30"
CONNECT ← the module is in ONLINE mode.
... exchange data...
```

```
+++ ← suspend the connection.
OK ← the module is in COMMAND mode.
```

```
AT#SH=6 ← close the connection. On server side is displayed the NO CARRIER
message.
```

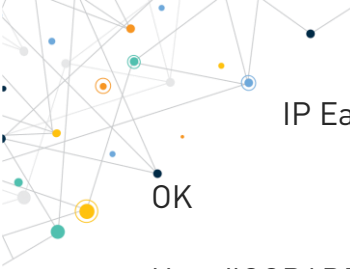

OK

Use #CGPADDR= command to verify the IP address assigned by the network to the modules after the GSM/PDP contexts activations.

16. DIALUP CONNECTION

The `ATD*99***<cid>#` command establishes a PSD connection between the module and an external PDN over the radio interface. This type of connection is initiated by using a character string instead of an ISP phone number, see chapter 14 for comparison only. After entering the dialup command, the data exchange between the user device and the module uses the PPP protocol that provides connection, authentication, transmission encryption, and compression, refer to Fig. 10.

Dial up connection and Multi-socket connections can be active at the same time but using different PDP context identifiers. In this configuration, the performances get worse. Usually, the dial up connection is used to make Web browsing.

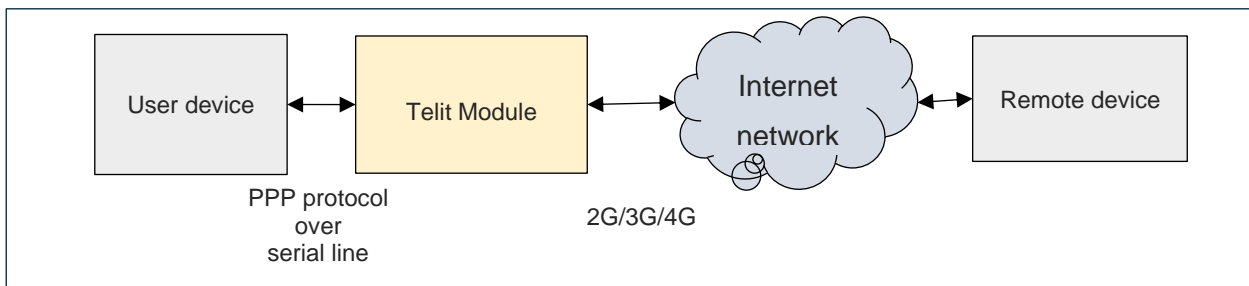

Figure 10: GPRS Dialup Connection

The command syntax is:

ATD*99*<cid>#**

Where:

99 GPRS Service Code
<cid> identifies the PDP context. To know the <cid> range see +CGDCONT command.

16.1. Examples

16.1.1. Start PPP Protocol

Assume that the PDP context <cid>=3 and the QoS have been configured. Establish a dial up connection using <cid>=3.

ATD*99*3#**

CONNECT ← the module is in ONLINE mode.

At this point, the user application must start the PPP protocol, which triggers the PDP context activation.

→ LCP Configure Request
 ← LCP Configure Acknowledge

- PAP Authentication
- ← PAP-Ack

- NCP (IP) Configure Request
- ← NCP (IP) Configure Acknowledge

..... start data packets exchange

Assume that the data packet exchange is ended. The user application must send the Terminate Request message.

- LCP Terminate Request
- ← LCP Terminate Acknowledge

Wait for NO CARRIER response. In alternative, send escape sequence.

+++ ← Use the +++ escape sequence to suspend the data connection. The module exits the ONLINE mode and enters the COMMAND mode. See the AT512 command to set timing relevant to escape sequence
 OK ← the module is in COMMAND mode.

Close the data call.

ATH
 OK

Refer to:

- RFC1661 to get LCP protocol and PPP protocol information.
- RFC1334 to get PAP protocol information.
- RFC1332 to get IPCP protocol information.



TCP/IP and PPP protocols description is beyond the scope of this document.

16.1.2. Dial-up Using <cid>=1 by default (2G)

This example shows ATD* command using <cid>=1 by default. The module is connected to a 2G network.

Check the current network operator.

AT+COPS?
 +COPS: 0,0,"network operator"



OK

Check the current cellular network.

AT+WS46?

+WS46: 12 ← 12 = GSM

OK

Check the current GPRS service attachment state.

AT+CGATT?

+CGATT: 1

OK

Define PDP context identified by <cid>=1.

AT+CGDCONT=1,"IP","Access_Point_Name"

OK

Type in the dialup command. The command uses the <cid>=1 by default.

ATD*99#

CONNECT ← the module is in ONLINE mode.

At this point, the user application must start the PPP protocol, which triggers the PDP context activation.

16.1.3. Dial-up Using <cid>=1 by default (3G)

This example shows the dialup command using <cid>=1 by default. The module is connected to a 3G network.

Check the current network operator.

AT+COPS?

+COPS: 1,0,"network operator",2 ← 2 = UTRAN

OK

Check the current cellular network.

AT+WS46?

+WS46: 25 ← GERAN and UTRAN

OK

Check the current GPRS service attachment state.

AT+CGATT?

+CGATT: 1

OK

Define PDP context identified by <cid>=1.



```
AT+CGDCONT=1,"IP","Access_Point_Name"  
OK
```

Type in the dialup command. The command uses the <cid>=1 by default.

```
ATD*99#
```

```
CONNECT ← the module is in ONLINE mode.
```

At this point, the user application must start the PPP protocol, which triggers the PDP context activation.

16.1.4. 4G Modules

16.1.4.1. Dial-up & #DUALAPN Command (Platform Version ID 20)

At power on, the PDP context identified by <cid>=1 uses "IP" and "Access_Point_Name", as returned by the AT+CGDCONT? read command shown below. For example, use the COM1 serial port to type in the command.

```
AT+CGDCONT?
```

```
+CGDCONT: 1,"IP","Access_Point_Name","",0,0
```

```
OK
```

Check if the module is registered on a 4G network.

```
AT+COPS?
```

```
+COPS: 0,0,"Network_Operator",7 ← 7 = E-UTRAN
```

```
OK
```

Check if the Default EPS Bearer is active

```
AT+CGCONTRDP=?
```

```
+CGCONTRDP: (1)
```

```
OK
```

Check the #DUALAPN mode.

```
AT#DUALAPN?
```

```
#DUALAPN: 0,0,0,0 ← 0 mode, default.
```

```
OK
```

If you assign to <cid>=2 the same APN and PDP type already in use with <cid>=1, the <cid>=2 is routed to the <cid>=1, according to AT#DUALAPN=0 mode (default), refer to chapter 5.8. Therefore, the IP address of both <cid> will be the same, see the following AT commands sequence.

```
AT+CGDCONT=2,"IP","Access_Point_Name"
```

```
OK
```

AT+CGDCONT?

```
+CGDCONT: 1,"IP","Access_Point_Name", "",0,0
+CGDCONT: 2,"IP","Access_Point_Name", "",0,0
OK
```

Only the first PDP context is active.

AT+CGPADDR=

```
+CGPADDR: 1,"2.192.16.194"
+CGPADDR: 2,""
OK
```

Now, for example, type in AT#PORTCFG=3 command, and reboot the module. To have information on #PORTCFG command refer to documents [4] or [10].

After rebooting, use COM2 port to start a dialup connection using AT2 instance.

The following dial up command establishes a Default EPS Bearer, and uses the <cid>=2, see the figure below.

ATD*99*2#**

CONNECT ← Module is in ONLINE mode.

Now, your application can start the PPP protocol on COM2 port, refer to chapter 16.1.1.

Use COM1 port to enter the next command to verify that <cid> 1 and 2 have the same IP address. If the PPP activation is successful, the two context identifiers have the same IP address, as stated before.

AT+CGPADDR=

```
+CGPADDR: 1,"2.192.16.194"
+CGPADDR: 2,"2.192.16.194"
OK
```

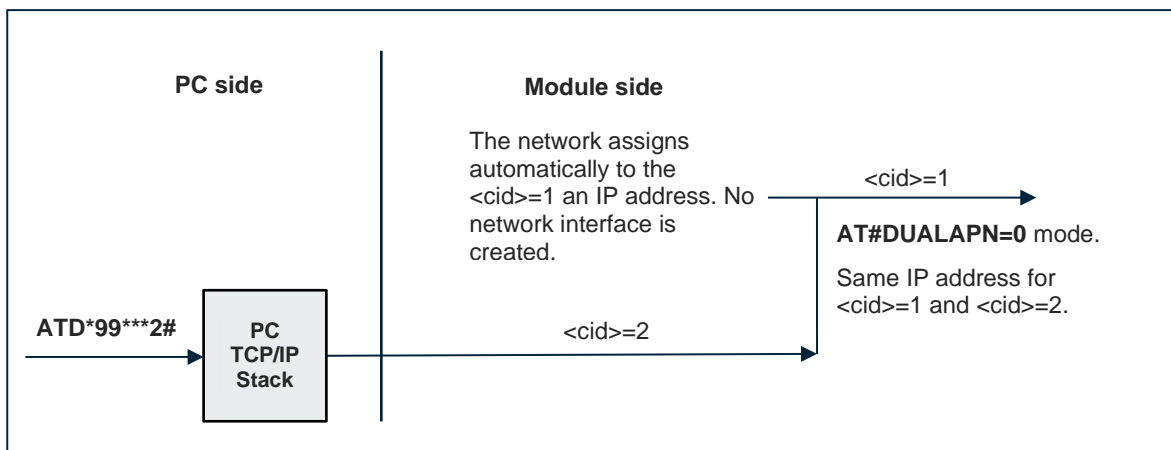

Figure 11: Dialup Connection using <cid>=2

16.1.4.2. Dial-up & #DUALAPN Command (Platform Version ID 20)

First, remember that:

- PPP is provided on Serial and USB ports. On USB port, PPP is supported only in router mode (AT#NWMODE=0,x,y. See chapter 16.7).
- AT#SGACT and Dial-up cannot run on the same <cid> (as stated in chapter 5.3).

Dial-up can be established using one of the following commands:

ATD*99# default cid (cid 3 for LE866-SV1 and ME866A1-NV1, see chapter 5.2.2.1, or else cid 1, see chapter 5.2.2.2)

ATD*991#** default cid (cid 3 for LE866-SV1 and ME866A1-NV1, see chapter 5.2.2.1, or else cid 1, see chapter 5.2.2.2)

ATD*991*<cid>#**

ATD*99*<cid>#**

Assume to use a Windows host: dial-up connection uses Standard 33600 Modem, see the figure below.

- Control Panel → Phone and Modem → Add Standard 33600 bps Modem selecting the AT interface to be used for Dial-up
- Control Panel → Network and Sharing Center. Set up a new connection → Connect to Internet → Dial-up.

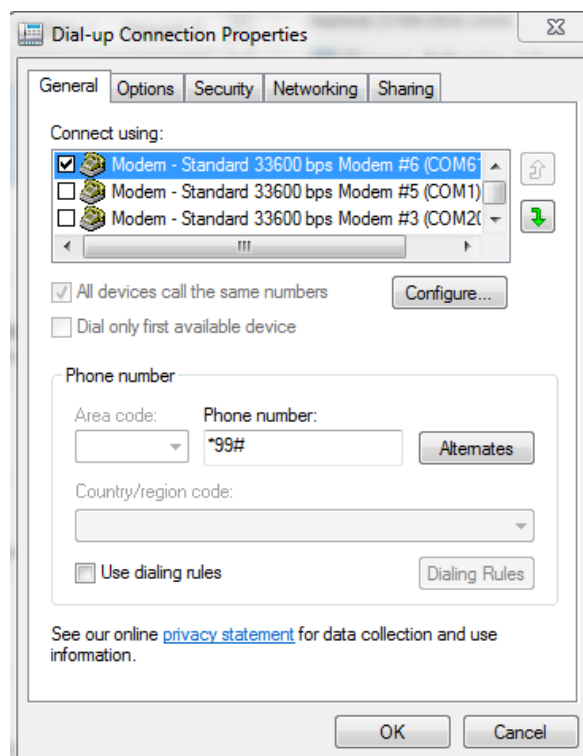

The IPv4 addresses, on the host side, is managed as described below. For the IPv6 addresses the host uses the global address provided by the network operator.

The PPP background process running on the module establishes a local network between the module and the host.

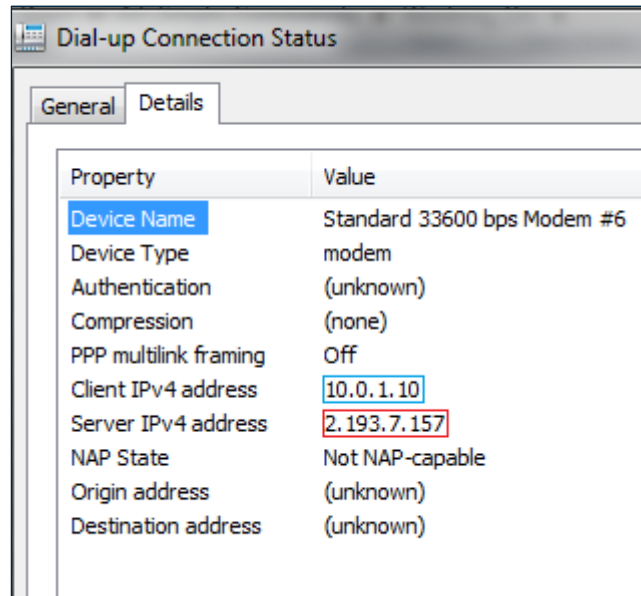

Property	Value
Device Name	Standard 33600 bps Modem #6
Device Type	modem
Authentication	(unknown)
Compression	(none)
PPP multilink framing	Off
Client IPv4 address	10.0.1.10
Server IPv4 address	2.193.7.157
NAP State	Not NAP-capable
Origin address	(unknown)
Destination address	(unknown)

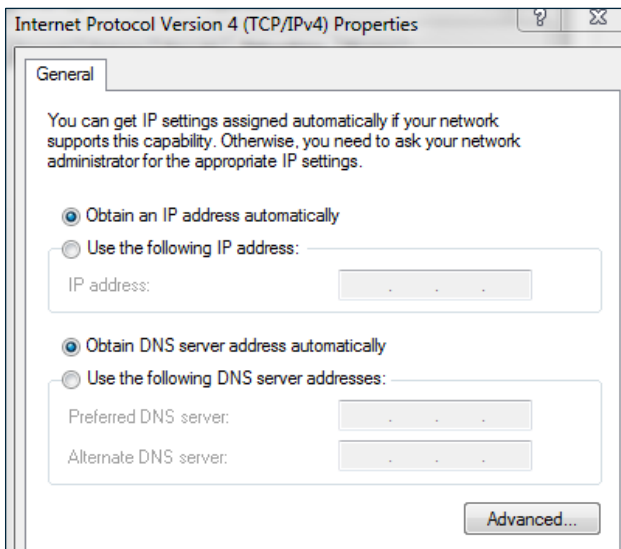

Server IP address is the address, assigned to the module by the network operator, see AT#GPPPCFG command, document [11].

If the host application does not include the host IP address (**Client address**) in the IPCP Configuration Request message, by default it is 10.0.1.10,

If the host application does not include the DNS operator server address in the IPCP Configuration Request message, it is automatically assigned to the host.

PPP Authentication

The modules support PAP and CHAP authentication.

- PPP authentication type is set through AT#GAUTH.
- PPP username and password should be saved in NVM by AT#GAUTHCFG.
- If PAP or CHAP is used, authentication is successfully managed if the host application uses the same credentials (**username** and **password**) saved in the module and these are accepted by operator during the PDP context activation automatically performed during dial-up.

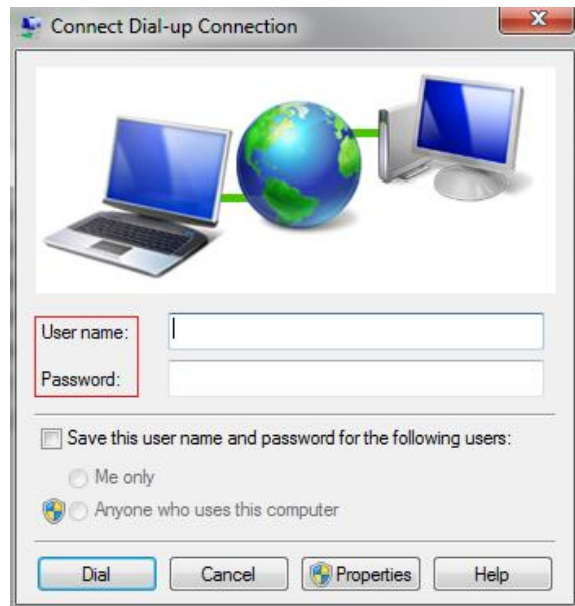

16.1.4.3. Dial-up Command, Platform Version ID 25, 30, 37

To get parameters descriptions for these platforms see documents [13], [14] or [15] according to the module used.

17. APPENDIX



General note for ALL Telit modules.

Localhost IP range doesn't perform any internal loopback therefore it shouldn't be used on any IP Easy command

17.1. IPv6 Protocol

Tab. 23 shows the Platform Version ID supporting IPV4 (IP), IPV6, and the dual IP stack (IPV4V6, see chapter 16.2). Refer to the Applicability Table to see the correspondence between the Platform Version ID and the products series.

Platform Version ID	Internet Protocol Version		
	IP Easy environment	Dial UP connection	Easy GSM
	PDP Context Type AT+CGDCONT=?		GSM Context Type AT#GSMCONT=?
10 (2G)	IP, IPV6	IP, IPV6	IP
13 (2G)	IP, IPV6	IP, IPV6	IP
16 (2G)	IP, IPV6	IP, IPV6	IP
12 (3G)	IP, IPV6, IPV4V6	IP, IPV6, IPV4V6	IP
20 (4G)	IP, IPV6, IPV4V6	IP, IPV6, IPV4V6	/
23 (4G)	IP, IPV6, IPV4V6	IP, IPV6, IPV4V6	/
25 (4G)	IP, IPV6, IPV4V6	IP, IPV6, IPV4V6	/
30 (4G)	IP, IPV6, IPV4V6	IP, IPV6, IPV4V6	/
37 (4G)	IP, IPV6, IPV4V6	IP, IPV6, IPV4V6	/

Tab. 23: Platform Version ID & IPV4/IPV6 Addresses

17.1.1. 2G Modules

Assume to use a module having 2G technology and enter the AT+CGDCONT=? test command to get the supported parameters values. The returned message shows that the stack of the module can manage IPV4 or IPV6 protocol.

AT+CGDCONT=?

+CGDCONT: (1-5),"IP",,,(0,1),(0,1)

+CGDCONT: (1-5),"IPV6",,,(0,1),(0,1)

OK

17.1.2. 3G Modules

Assume to use a module having 3G technology and enter the AT+CGDCONT=? test command to get the supported parameters values. The returned message shows that the module provides a dual IP stack (IPV4V6) that can manage at the same time IPV4 and IPV6 protocols.

AT+CGDCONT=?

```
+CGDCONT: (1-5),"IP",,,(0,1),(0,1)
+CGDCONT: (1-5),"IPV6",,,(0,1),(0,1)
+CGDCONT: (1-5),"IPV4V6",,,(0,1),(0,1)
OK
```

17.1.3. 4G Modules

Assume to use a module having 4G technology and enter the AT+CGDCONT=? test command to get the supported parameters values. The returned message shows that the module provides a dual IP stack (IPV4V6) that can manage at the same time IPV4 and IPV6 protocols. Here is an example for LE910-EU1 module having Platform Version ID 20.

AT+CGDCONT=?

```
+CGDCONT: (1-15),"IP",,,0,(0-4),(0,1),(0,1),(0,1),(0,1)
+CGDCONT: (1-15),"IPV6",,,0,(0-4),(0,1),(0,1),(0,1),(0,1)
+CGDCONT: (1-15),"IPV4V6",,,0,(0-4),(0,1),(0,1),(0,1),(0,1)
OK
```



Platform Version ID 23:

the modules must be configured in bridge mode (see #NWMODE command, chapter 16.7) to work with IPV6.

17.2. IPv4, IPv6 and Dual Stack

17.2.1. 2G/3G/4G Modules

Referring to Fig. 12.

Define PDP context <cid>=1 using IPV4 ("IP").

AT+CGDCONT=1,"IP","Access_Point_Name"

OK

AT#SGACT = 1,1

← activate PDP context <cid>=1



#SGACT: 31.157.55.95
OK

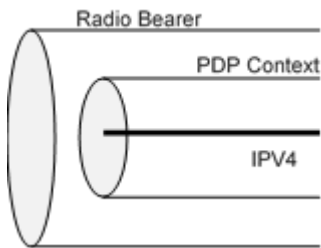

Figure 12: IPv4

#SL command is listening only on IPV4 connections.

Referring to Fig. 13.

Define PDP context <cid>=2 using IPV6.

```
AT+CGDCONT=2,"IPV6","Access_Point_Name"
```

OK

```
AT#SGACT=2,1 ← activate the PDP
```

```
#SGACT: 42.1.1.152.2.76.193.109.0.0.0.5.17.176.201.1
```

OK

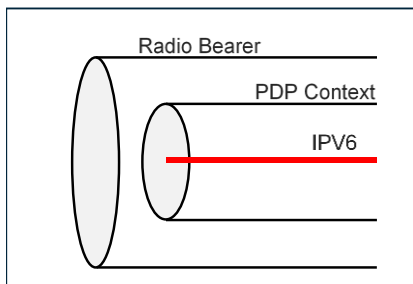

Figure 13: IPv6

#SL command is listening only on IPV6 connections.

17.2.2. 3G/4G Modules

Referring to figure below.

Define PDP context <cid>=1 using IPV4V6.

```
AT+CGDCONT=1,"IPV4V6","Access_Point_Name"
```

OK

```
AT#SGACT=1,1 ← activate the PDP context 1
```

```
#SGACT: 31.157.55.95,42.1.1.152.2.76.193.109.0.0.0.5.17.176.201.1
```

OK

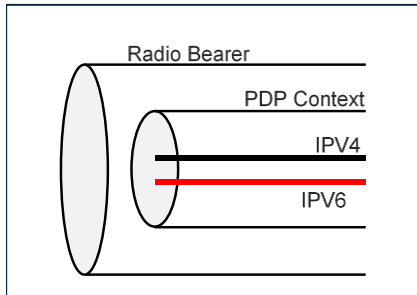

Figure 14: Dual IP Stack IPv4v6

Using dual IP stack, #SL command is listening on IPV4 and IPV6. If the first received packet is an IPV4 packet, the connection will continue to use only IPV4 packets, and IPV6 packets are discarded. Conversely, if the first received packet is an IPV6 packet. If you need to filter out some IP addresses use the firewall command, see chapter 7.4.

17.3. IPv6 Notation

The AT commands supporting the IPV6 address accept two IPV6 notation.

Dotted-decimal notation:

- xxx.xxx.xxx.xxx.xxx.xxx.xxx.xxx.xxx.xxx.xxx.xxx.xxx.xxx.xxx
- Where xxx is a number having the range: 000 – 255

Hexadecimal notation:

- yyyy:yyyy:yyyy:yyyy:yyyy:yyyy:yyyy:yyyy
- Where yyyy is expressed in hexadecimal format

The AT commands return the IPV6 addresses always in the dotted-decimal notation.

17.3.1. +CGPIAF Command

4G modules provide the +CGPIAF command to select the format used to display the IPV6 address. The command syntax is:

```
AT+CGPIAF=[<IPV6_AddressFormat>[,<IPV6_SubnetNotation>
           [,<IPV6_leadingZeros>[,<IPV6_compressZeros>]]]]
```

To have information on the parameters meaning refer to documents [4], [11], [13], [14] or [15] in accordance with the module you are using.

17.4. Examples

17.4.1. +CGDCONT Command & IPV6 Notation

Assume to use a 2G module and enter the +CGDCONT test command.

AT+CGDCONT=?

+CGDCONT: (1-5),"IP",,,(0,1),(0,1)

+CGDCONT: (1-5),"IPV6",,,(0,1),(0,1)

OK

Define PDP context <cid>=1 using IPV6.

AT+CGDCONT=1,"IPV6","Access_Point_Name"

OK

Activate the PDP Context. The command returns the IPV6 address assigned by the network to the module in dotted-decimal notation.

AT#SGACT=1,1

+IP: 42.1.1.152.2.76.193.109.0.0.0.5.17.176.201.1

OK

17.4.2. #SD Command & IPV6 Notation

Configure the socket.

AT#SCFG=1,1,300,90,600,50

OK

Open a socket connection using IPV6 in dotted-decimal notation.

AT#SD=1,0,80,"32.1.7.0.0.0.1.46.0.0.0.0.0.15.112",0

CONNECT

.....

Open a socket connection using IPV6 in hexadecimal notation.

AT#SD=1,0,80," 2001:700:0:12e::f70",0

CONNECT

.....

17.4.3. #FTPOPEN Command & IPV6 Notation

Open an FTP connection using IPV6 in dotted-decimal notation.

```
AT#FTPOPEN="32.1.7.0.0.0.1.46.0.0.0.0.0.15.112","", "",1
OK
```

Open an FTP connection using IPV6 in hexadecimal notation.

```
AT#FTPOPEN="2001:700:0:12e::f70","", "",1
OK
```

17.4.4. #PING Command & IPV6 Notation

Ping remote host using IPV6 in dotted-decimal notation.

```
AT#PING="32.1.7.0.0.0.1.46.0.0.0.0.0.15.112"
#PING: 01," 32.1.7.0.0.0.1.46.0.0.0.0.0.15.112",47,237
...
OK
```

Ping remote host using IPV6 in hexadecimal notation.

```
AT#PING="2001:700:0:12e::f70"
#PING: 01," 32.1.7.0.0.0.1.46.0.0.0.0.0.15.112",47,237
...
OK
```

17.4.5. #DNS Command & IPV6 Notation

Set primary and secondary DNS server. Use the hexadecimal notation for the IPV6 addresses.

```
AT#DNS=1,"2001:4860:4860::8888","2001:4860:4860::8844"
OK
```

Check the DNS addresses set manually. The IPV6 addresses are returned in dotted-decimal notation.

```
AT#DNS?
#DNS:
1,"32.1.72.96.72.96.0.0.0.0.0.0.0.136.136","32.1.72.96.72.96.0.0.0.0.0.0.0.136.68"
OK
```



#DNS Command not present on Platform Version ID 30, 37.

17.4.6. #FRWLIPV6 Command & IPV6 Notation

Add an ACCEPT chain. Use the hexadecimal notation for the IPV6 addresses.

```
AT#FRWLIPV6=1,"2001:700:0:12e::f70","ffff:ffff:ffff:ffff:ffff:ffff:ffff:ffff"
OK
```

Check all the ACCEPT chains. The command returns the IPV6 addresses in dotted-decimal notation.

```
AT#FRWLIPV6?
#FRWLIPV6:"32.1.7.0.0.0.1.46.0.0.0.0.0.0.0.15.112","255.255.255.255.255.255.255.255.255.255.255.255.255.255"
OK
```

17.5. #NCN Command

#NCM command sets up the Network Control Model protocol. The command provides two modes to establish a Default EPS Bearer:

- mode=1 (see chapter 16.5.1)
- mode=2 (see chapter 16.5.2)



#NCM command does not belong to the IP Easy environment and is available on modules having Platform Version ID 20, see documents [4], and [9].

17.5.1. #NCM Command, Mode=1

Assume to use the #NCM command configured in NCM mode =1 (manual PDP context activation). In addition, #NCM command configuration does not use authentication parameters. To set the authentication parameters use the #PDPAUTH command.

At power on, assume that the PDP context identified by <cid>=1 has not defined APN.

```
AT+CGDCONT?
+CGDCONT: 1,"IPV4V6","","",0,0
OK
```

After attach procedure, the PDP context identified by <cid>=1 is automatically associated to the Default EPS Bearer assigned by the Network Operator in response of the not defined APN.

Read the PDP context dynamic parameters.

AT+CGCONTRDP=1

+CGCONTRDP:

1,
5,
"APN_Assigned_by_Network",
"100.87.125.10.255.0.0.0",
"100.87.125.11",
"80.201.237.239",
"0.0.0.0","0.0.0.0",
"0.0.0.0"
OK

Set up the new PDP Context identified by <cid>=3.

AT+CGDCONT=3,"IPV4V6","Access_Point_Name"

OK

Set the PDP authentication parameters on PDP context <cid>=3.

AT#PDPAUTH=3,1,"UserName","PassWord"

OK

Activate the PDP Context identified by <cid>=3.

AT+CGACT=1,3

OK

Check the PDP contexts dynamic parameters assigned by the Network Operator.

AT+CGCONTRDP=

+CGCONTRDP:

1, ← PDP context activated during attach procedure
5,
"APN_Assigned_by_Network",
"100.114.19.108.255.0.0.0",
"100.114.19.109",
"80.201.237.239",
"0.0.0.0",
"0.0.0.0",
"0.0.0.0"

+CGCONTRDP:

3, ← PDP context activated by +CGACT command
6,

```
"Access_Point_Name.....",  
"10.113.0.66.255.0.0.0",  
"10.113.0.67",  
"8.8.4.4",  
"0.0.0.0",  
"0.0.0.0",  
"0.0.0.0"  
OK
```

You must configure your PC to use the NCM command, refer to document [9].
Use NMC mode = 1 and assign the NCM protocol to PDP context identified by <cid> = 3.

```
AT#NCM=1,3  
OK
```

Use the AT+CGDATA=? test command to check the protocols supported by the module.

```
AT+CGDATA=?  
+CGDATA: ("PPP","M-HEX","M-RAW_IP"),(1-15)  
OK
```

Activate the NCM protocol, refer to document [9].

```
AT+CGDATA="M-RAW_IP",3  
CONNECT  
OK
```

17.5.2. #NCM Command, Mode=2

This example focuses on the use of:

- I. #NCM with authentication parameters. If you use the AT#PDPAUTH command, and then use the AT#NCM command with new authentication parameters, the authentication process is performed using the last entered parameters.
- II. #NCM command in NCM mode = 2 (automatic PDP context and NCM activation).

At power on, assume that the PDP context identified by <cid>=1 has not defined APN.

```
AT+CGDCONT?  
+CGDCONT: 1,"IPV4V6","","",0,0  
OK
```

After attach procedure, the PDP context identified by <cid>=1 is automatically associated to the Default EPS Bearer assigned by the Network Operator in response of the not defined APN (see +CGDCONT? command above).

Read the PDP context dynamic parameters.

```
AT+CGCONTRDP=1
```



```
+CGCONTRDP:
1,
5,
"APN_Assigned_by_Network",
"100.80.28.204.255.0.0.0","100.80.28.205",
"80.201.237.239",
"0.0.0.0","0.0.0.0",
"0.0.0.0"
OK
```

Set up the new PDP Context associated to <cid>=1.

```
AT+CGDCONT=1,"IPV4V6","Access_Point_Name"
OK
```

Verify the entered PDP Context.

```
AT+CGDCONT?
+CGDCONT: 1,"IPV4V6","Access_Point_Name","",0,0
OK
```

Set the PDP authentication parameters on PDP context <cid>=1. This authentication parameters will be overwritten by the #NCM command used at the end of this example.

```
AT#PDPAUTH=1,1,"UserName","PassWord"
OK
```

Detach the module from the network.

```
AT+CGATT=0
OK
```

Verify if the module is detached.

```
AT+CGATT?
+CGATT: 0
OK
```

You must configure your PC to use the NCM command, refer to document [9].

Using the NCM mode = 2, the command activates automatically the PDP context identified by the <cid> (in this case <cid>=1). The authentication parameters override the previous Username and Password entered through the #PDPAUTH command.

```
AT#NCM=2,1,0,"UserName","PassWord"
OK
```

Verify the state of the PDP Context.

```
AT+CGACT?
+CGACT: 1,1
OK
```

Check the PDP context dynamic parameters assigned by the Network Operator in response of the user defined PDP context activated by the #NCM command.

AT+CGCONTRDP=1

+CGCONTRDP:

1,

5,

"Access_Point_Name.....",

"10.113.0.66.255.0.0.0",

"10.113.0.67",

"8.8.4.4",

"0.0.0.0",

"0.0.0.0",

"0.0.0.0"

OK

17.6. #MBIMCFG Command

#MBIMCFG command selects the <cid> that will be used by MBIM standard when a connection will be established. The host (PC) is connected to the device (module) through a USB port. The device uses the assigned <cid> and starts the connection. The command syntax is:

AT#MBIMCFG=<cid>



#MBIMCFG command does not belong to the IP Easy environment and is available on modules having Platform Version ID 20, see document [4]

17.6.1. Modules: LE910 Series

Modules: LE910-EU1, B1-EU, -JN1, -NA1, B1-NA, B1-SA, -NA V2, B4-NA, -EU V2, AU V2

Check the available <cid> for the MBIM standard.

AT#MBIMCFG=?

#MBIMCFG: {1-15}

OK

Check the current <cid> assigned to the MBIM standard

AT#MBIMCFG?

#MBIMCFG: 15

OK

17.6.2. Modules: LE910-SV1, -SVL, SV V2

Check the module identification.

AT+CGMM

LE910-SV1

OK

In this product, only <cid> = 3 can be used by MBIM standard.

AT#MBIMCFG=?

#MBIMCFG: {3}

OK

Check the current <cid> assigned to the MBIM standard

AT#MBIMCFG?

#MBIMCFG: 3

OK

17.7. #NWMODE Command

#NWMODE command sets the network configuration on USB port, on which is running the RNDIS/ECM protocols. After entering this command, the module reboots. The command syntax is:

AT#NWMODE=<mode>,<dhcp>,<dmz>



#NWMODE command does not belong to the IP Easy environment and is available on modules having Platform Version ID 23, see document [11].

Here is how to use the PPP protocol, and configure the module in router or bridge mode.

- In router mode, the module and the host establish a local network. If is used
 - IPv4 protocol, the host has a unique local address.
 - IPv6 protocol, the host may have also a global address.
- In bridge mode, the host has the addresses assigned directly by the network operator.

➤ The PPP protocol is available only in router mode.

#NWMODE=0,0,0 default configuration, module set for no inbound data to the host;

<mode>=0: router mode;

<dhcp> =0: DHCP on USB-RNDIS/ECM is disabled.

Host IPv4 address is set manually at 10.0.0.10. To the host is also assigned a link local IPv6 address.

Note: the 10.0.1.10 address (see chapter 15.1.4.2) is active when PPP is running. Therefore, the host may have both addresses 10.0.1.10 and 10.0.0.10 if PPP is running, and USB active.

<dmz> =0: module server services are accessible from outside. The host cannot be accessed from outside (no inbound data to the host).
The start of the PPP protocol triggers the PDP context activation, see chapter 15.1.1.
If PPP protocol is not running, the host can use the USB-RNDIS/ECM connection to reach the external network. The PDP context must be active.

#NWMODE=0,0,2 module set for inbound data to the host;

<mode>=0: router mode;

<dhcp> =0: DHCP on USB-RNDIS/ECM is disabled.

Host IPv4 address is set manually at 10.0.0.10. To the host is also assigned a link local IPv6 address.

Note: the 10.0.1.10 address (see chapter 15.1.4.2) is active when PPP is running. Therefore, the host may have both addresses 10.0.1.10 and 10.0.0.10 if PPP is running, and USB active.

<dmz> =2: host server services are accessible from outside through PPP protocol (inbound data to the host).
The start of the PPP protocol triggers the PDP context activation, see chapter 15.1.1.
If PPP protocol is not running, the host can use the USB-RNDIS/ECM connection to reach the external network. The PDP context must be active.

#NWMODE=0,1,0 network operator assigns to the host the global address IPv6;

<mode>=0: router mode;

<dhcp> =1: DHCP on USB-RNDIS/ECM is enabled as in a local network.

Host IPv4 address is automatically set at 10.0.0.10.

To the host are also assigned the global and link local IPv6 addresses. Global address prefix is allocated by the network operator.

<dmz> =0: module server services are accessible from outside. The host cannot be accessed from outside (no inbound data to the host),
The host can use the USB-RNDIS/ECM connection to reach the external network. The PDP context must be active.

- The PPP protocol is not available in bridge mode.

#NWMODE=1,1,1 network operator assigns to the host the IPv4, and the global address IPv6. The module works like a modem;

<mode>=1: bridge mode;

<dhcp> =1: DHCP on USB-RNDIS/ECM is enabled, in this configuration the host sees the module like a modem, it means that #SD, #HTTP, #FTP, and #SSL AT commands are not available.

Host IP address is automatically set using the IP address provided by the network operator. To the host are also assigned the global and link local IPv6 addresses. Global address prefix is assigned by the network operator.

<dmz> =1: server services in the host are accessible from outside via USB-RNDIS/ECM connection (inbound data to the host). <dhcp> must be set to 1. PDP context must be active.

17.8. Obsolete Commands

Historically, IP Easy Extension is an improvement of the first IP Easy environment. To underline the differences between IP Easy and IP Easy Extension environments, here is the correspondence table between the obsolete commands of the IP Easy environment and the new commands of the IP Easy Extension environment. It is strongly recommended to use only the commands set of the IP Easy Extension environment, and do not mix obsolete and new commands. In chapter 3, IP Easy term indicates the IP Easy Extension.

IP Easy	IP Easy Extension	
Obsolete commands	New commands	Operation description
AT#SKTOP	AT#SGACT; AT#SD	socket open
AT#SKTD	AT#SD	socket dial
AT#SKTL	AT#SL	socket listen
AT#SKTSET	not required	
AT#SKTSAV	not required	
AT#GPRS	AT#SGACT	activation of context
+++ after AT#SKTD	+++; AT#SH	socket close
+++ after AT#SKTOP	+++; AT#SH; AT#SGACT	
AT#USERID	AT#SGACT	authentication
AT#PASSWD	AT#SGACT	
AT#PKTSZ	AT#SCFG	socket configuration
AT#DSTO	AT#SCFG	
AT#SKTTO	AT#SCFG	
AT#SKTCT	AT#SCFG	

Tab. 24: Obsolete and New AT Commands



Obsolete commands are not available on Platform Version ID 30, 37.

Obsolete commands in Multi-socket environment

#SKTD and #SKTL obsolete commands (IP Easy) are available also on modules providing the Multi-socket feature (IP Easy Extension). They work in the old-fashioned: when a connection is opened with #SKTD, it cannot be suspended and the escape sequence (+++) closes definitively the connection.

#SKTOP must be not use with the new Multi-socket commands because it deactivates the context when the connection is closed, this could close the suspended sockets.

CMUX and obsolete commands

Using CMUX tool, the module provides three virtual serial lines connected to three AT parsers, refer to document [6]. Assume that one HTTP (or SMTP, FTP) session is already opened on a CMUX virtual port. If you try to open a second HTTP client connection on another CMUX virtual port, the HTTP command returns an error message. When the old HTTP connection is closed, the new one can be opened.

CMUX protocol allows the use of three virtual port to enter AT commands, refer to document [6]. #SKTD allows opening three simultaneous connections. The connections are closed by means of the escape sequence (+++).

#SKTOP is a mono-socket command and works only with <cid>=1 and <connId>=1, therefore it can be used only on one virtual port of CMUX.

18. PRODUCT AND SAFETY INFORMATION

18.1. Copyrights and Other Notices

SPECIFICATIONS ARE SUBJECT TO CHANGE WITHOUT NOTICE

Although reasonable efforts have been made to ensure the accuracy of this document, Telit assumes no liability resulting from any inaccuracies or omissions in this document, or from the use of the information contained herein. The information in this document has been carefully checked and is believed to be reliable. Telit reserves the right to make changes to any of the products described herein, to revise it and to make changes from time to time with no obligation to notify anyone of such revisions or changes. Telit does not assume any liability arising from the application or use of any product, software, or circuit described herein; neither does it convey license under its patent rights or the rights of others.

This document may contain references or information about Telit's products (machines and programs), or services that are not announced in your country. Such references or information do not necessarily mean that Telit intends to announce such Telit products, programming, or services in your country.

18.1.1. Copyrights

This instruction manual and the Telit products described herein may include or describe Telit's copyrighted material, such as computer programs stored in semiconductor memories or other media. Laws in Italy and in other countries reserve to Telit and its licensors certain exclusive rights for copyrighted material, including the exclusive right to copy, reproduce in any form, distribute and make derivative works of the copyrighted material. Accordingly, any of Telit's or its licensors' copyrighted material contained herein or described in this instruction manual, shall not be copied, reproduced, distributed, merged or modified in any manner without the express written permission of the owner. Furthermore, the purchase of Telit's products shall not be deemed to grant in any way, neither directly nor by implication, or estoppel, any license.

18.1.2. Computer Software Copyrights

Telit and the 3rd Party supplied Software (SW) products, described in this instruction manual may include Telit's and other 3rd Party's copyrighted computer programs stored in semiconductor memories or other media. Laws in Italy and in other countries reserve to Telit and other 3rd Party SW exclusive rights for copyrighted computer programs,

including – but not limited to - the exclusive right to copy or reproduce in any form the copyrighted products. Accordingly, any copyrighted computer programs contained in Telit's products described in this instruction manual shall not be copied (reverse engineered) or reproduced in any manner without the express written permission of the copyright owner, being Telit or the 3rd Party software supplier. Furthermore, the purchase of Telit products shall not be deemed to grant either directly or by implication, estoppel, or in any other way, any license under the copyrights, patents or patent applications of Telit or other 3rd Party supplied SW, except for the normal non-exclusive, royalty free license to use arising by operation of law in the sale of a product.

18.2. Usage and Disclosure Restrictions

18.2.1. License Agreements

The software described in this document is owned by Telit and its licensors. It is furnished by express license agreement only and shall be used exclusively in accordance with the terms of such agreement.

18.2.2. Copyrighted Materials

The Software and the documentation are copyrighted materials. Making unauthorized copies is prohibited by the law. The software or the documentation shall not be reproduced, transmitted, transcribed, even partially, nor stored in a retrieval system, nor translated into any language or computer language, in any form or by any means, without prior written permission of Telit.

18.2.3. High Risk Materials

Components, units, or third-party goods used in the making of the product described herein are NOT fault-tolerant and are NOT designed, manufactured, or intended for use as on-line control equipment in the following hazardous environments requiring fail-safe controls: operations of Nuclear Facilities, Aircraft Navigation or Aircraft Communication Systems, Air Traffic Control, Life Support, or Weapons Systems ("High Risk Activities"). Telit and its supplier(s) specifically disclaim any expressed or implied warranty of fitness eligibility for such High Risk Activities.

18.2.4. Trademarks

TELIT and the Stylized T-Logo are registered in the Trademark Office. All other product or service names are property of their respective owners.

18.2.5. 3rd Party Rights

The software may include 3rd Party's software Rights. In this case the user agrees to comply with all terms and conditions imposed in respect of such separate software rights. In addition to 3rd Party Terms, the disclaimer of warranty and limitation of liability provisions in this License, shall apply to the 3rd Party Rights software as well.

TELIT HEREBY DISCLAIMS ANY AND ALL WARRANTIES EXPRESSED OR IMPLIED FROM ANY 3RD PARTY REGARDING ANY SEPARATE FILES, ANY 3RD PARTY MATERIALS INCLUDED IN THE SOFTWARE, ANY 3RD PARTY MATERIALS FROM WHICH THE SOFTWARE IS DERIVED (COLLECTIVELY "OTHER CODES"), AND THE USE OF ANY OR ALL OTHER CODES IN CONNECTION WITH THE SOFTWARE, INCLUDING (WITHOUT LIMITATION) ANY WARRANTIES OF SATISFACTORY QUALITY OR FITNESS FOR A PARTICULAR PURPOSE.

NO 3RD PARTY LICENSORS OF OTHER CODES MUST BE LIABLE FOR ANY DIRECT, INDIRECT, INCIDENTAL, SPECIAL, EXEMPLARY, OR CONSEQUENTIAL DAMAGES (INCLUDING WITHOUT LIMITATION LOST OF PROFITS), HOWEVER CAUSED AND WHETHER MADE UNDER CONTRACT, TORT OR OTHER LEGAL THEORY, ARISING IN ANY WAY OUT OF THE USE OR DISTRIBUTION OF THE OTHER CODES OR THE EXERCISE OF ANY RIGHTS GRANTED UNDER EITHER OR BOTH THIS LICENSE AND THE LEGAL TERMS APPLICABLE TO ANY SEPARATE FILES, EVEN IF ADVISED OF THE POSSIBILITY OF SUCH DAMAGES.

18.2.6. Waiver of Liability

IN NO EVENT WILL TELIT AND ITS AFFILIATES BE LIABLE FOR ANY DIRECT, INDIRECT, SPECIAL, GENERAL, INCIDENTAL, CONSEQUENTIAL, PUNITIVE OR EXEMPLARY INDIRECT DAMAGE OF ANY KIND WHATSOEVER, INCLUDING BUT NOT LIMITED TO REIMBURSEMENT OF COSTS, COMPENSATION OF ANY DAMAGE, LOSS OF PRODUCTION, LOSS OF PROFIT, LOSS OF USE, LOSS OF BUSINESS, LOSS OF DATA OR REVENUE, WHETHER OR NOT THE POSSIBILITY OF SUCH DAMAGES COULD HAVE BEEN REASONABLY FORESEEN, CONNECTED IN ANY WAY TO THE USE OF THE PRODUCT/S OR TO THE INFORMATION CONTAINED IN THE PRESENT DOCUMENTATION, EVEN IF TELIT AND/OR ITS AFFILIATES HAVE BEEN ADVISED OF THE POSSIBILITY OF SUCH DAMAGES OR THEY ARE FORESEEABLE OR FOR CLAIMS BY ANY THIRD PARTY.

18.3. Safety Recommendations

Make sure the use of this product is allowed in your country and in the environment required. The use of this product may be dangerous and has to be avoided in areas where:

- it can interfere with other electronic devices, particularly in environments such as hospitals, airports, aircrafts, etc.
- there is a risk of explosion such as gasoline stations, oil refineries, etc. It is the responsibility of the user to enforce the country regulation and the specific environment regulation.

Do not disassemble the product; any mark of tampering will compromise the warranty validity. We recommend following the instructions of the hardware user guides for correct wiring of the product. The product has to be supplied with a stabilized voltage source and the wiring has to be conformed to the security and fire prevention regulations. The product has to be handled with care, avoiding any contact with the pins because electrostatic discharges may damage the product itself. Same cautions have to be taken for the SIM, checking carefully the instruction for its use. Do not insert or remove the SIM when the product is in power saving mode.

The system integrator is responsible for the functioning of the final product. Therefore, the external components of the module, as well as any project or installation issue, have to be handled with care. Any interference may cause the risk of disturbing the GSM network or external devices or having an impact on the security system. Should there be any doubt, please refer to the technical documentation and the regulations in force. Every module has to be equipped with a proper antenna with specific characteristics. The antenna has to be installed carefully in order to avoid any interference with other electronic devices and has to guarantee a minimum distance from the body (20 cm). In case this requirement cannot be satisfied, the system integrator has to assess the final product against the SAR regulation.

The equipment is intended to be installed in a restricted area location.

The equipment must be supplied by an external specific limited power source in compliance with the standard EN 62368-1:2014.

The European Community provides some Directives for the electronic equipment introduced on the market. All of the relevant information is available on the European Community website:

https://ec.europa.eu/growth/sectors/electrical-engineering_en

19. GLOSSARY

TTSC	Telit Technical Support Centre
USB	Universal Serial Bus
HS	High Speed
DTE	Data Terminal Equipment
UMTS	Universal Mobile Telecommunication System
WCDMA	Wideband Code Division Multiple Access
HSDPA	High Speed Downlink Packet Access
HSUPA	High Speed Uplink Packet Access
UART	Universal Asynchronous Receiver Transmitter
HSIC	High Speed Inter Chip
SIM	Subscriber Identification Module
SPI	Serial Peripheral Interface
ADC	Analog – Digital Converter
DAC	Digital – Analog Converter
I/O	Input Output
GPIO	General Purpose Input Output
CMOS	Complementary Metal – Oxide Semiconductor
MOSI	Master Output – Slave Input
MISO	Master Input – Slave Output
CLK	Clock
MRDY	Master Ready
SRDY	Slave Ready
CS	Chip Select
RTC	Real Time Clock
PCB	Printed Circuit Board
ESR	Equivalent Series Resistance
VSWR	Voltage Standing Wave Ratio
VNA	Vector Network Analyzer

20. DOCUMENT HISTORY

Revision	Date	Changes
26	2021-07-22	Added chapter MQTT Protocol
25	2021-02-19	<p>The document is fully revised, and chapters are reorganized. A new template is used.</p> <p>Added clauses 5.2.4, 5.4.4, 5.8.2, 5.9.2 and 11.3.3.</p> <p>Product series added: ME910C1 SERIES, ML865C1 SERIES; ME310G1 SERIES, ME910G1 SERIES, ML865G1 SERIES.</p>
24	2019-07-10	Product series added: LE910Cx
23	2017-10-24	<p>The document is fully revised, and chapters are reorganized. A new template is used.</p> <p>Product series removed: GC864, GE864, GT86x, UC864, UE910 V2, and HE910 V2.</p> <p>Product series added: LE910 Cat1, LE910 V2, LE866, and ME866A1.</p> <p>Revised chapter 6.1 Firewall Setting.</p> <p>Added HTTP POST and PUT examples Added: chapters 15.1.4.2 Dial-up Command, Platform ID 23; 16.7 #NWMODE</p>
22	2015-11-10	Updated the table in chapter 6. SW version 12.00.xxx supports IPV6 in IP Easy
21	2014-11-17	Added the note "... open a socket with #SD ..." in chapter 3.2
20	2014-10-21	Chapter 3.2.3: changed the two footnotes
19	2014-09-03	Products added: UE910-EU V2 / 19.10.xx2 UE910-NA V2 / 19.10.xx2 UE910-EU V2 AUTO / 19.10.xx2 HE910-EU V2 / 14.22.xx1 HE910-EUG V2 / 14.22.xx1 HE910-NA V2 / 14.22.xx1 HE910-NAG V2 / 14.22.xx1 HE920-EU AUTO / 14.12.xx1 HE920-NA AUTO / 14.12.xx1
18	2014-07-14	Chapter 6.1.1: correct the syntax of the AT#SL command listed in the first table of the chapter.
17	2014-04-18	Added chapters 8 and 10 Chapter 3.7.1.- "IP Easy- HTTP client application" was renamed to "IP Easy HTTP client with #SD" Chapter 3.7.2. - "IP Easy - EMAIL sending application" was renamed to "IP Easy - EMAIL sending with #SD" and part with AT#SMTPCL /

		<p>AT#EMAILD was removed</p> <p>Chapter 3.7.3 - "IP Easy -EMAIL receiving application" was renamed to "IP Easy -EMAIL receive with #SD"</p> <p>IPv6 table updated in chapter 6.- "Notes concerning IPV6 Implementation"</p>
16	2014-03-06	<p>Changed sentence in Chapter 10.5.4</p> <p>Products added</p>
15	2013-02-19	<p>Updated Applicability Table and chapter 1.4</p> <p>Added IPV6 parameter value relating +CGDCONT command in chapter 3.1</p> <p>Modified max number of bytes from 1024 to 1500 in chapter 7.3. Added chapter 16.1</p>
14	2013-02-07	<p>Removed a note in chapter 3.5.1. Updated Applicability Table.</p>
13	2012-10-09	<p>Updated Applicability and SW Versions tables.</p> <p>Modified values range of the <srMode> parameter of the AT#SCFGEXT command.</p> <p>Added new commands #FTPAPPEXT, #SLASTCLOSURE</p>
12	2011-10-20	<p>Update related to differences relating to SW versions starting from 12.00.xx1</p>
11	2011-10-17	<p>Updated software versions</p> <p>Corrected mistake in note at par 2.1.3</p>
10	2011-03-09	<p>Added new features related to sw release 10.0.04 such as:</p> <ul style="list-style-type: none"> - AT#SMTPCL command, it allows to send an email with different types of attachments. #SMTPCL handles attachment, managing MIME headers and encoding if required. <p>Updated all references from "GPRS" to "GPRS/UMTS/HSPA"(or removed when not required)</p> <p>Correction on #SSENDEXT referenced wrongly as "#SEND" at page 78; par. 5.2.3</p> <p>Correction on par. 5.2.1(pag.74), reference to #SD / cmd mode (was wrongly indicated as "Atem")</p> <p>Added general note regarding availability of commands on different SW version</p> <p>Changed title from EASY GPRS User Guide to IP Easy User Guide</p>
9	2010-10-04	<p>Added GL865-DUAL to applicability table</p>
8	2010-07-26	<p>Added new features related to sw release 7.03.02 or 7.02.07 such as:</p> <ul style="list-style-type: none"> - added new socket configuration parameters (see new #SCFGEXT2 command) - added new command #SSENDEXT for sending data in command mode <p>Added new features related to sw release 7.03.02 ,7.02.07 or 10.0.02 such as:</p>

		<ul style="list-style-type: none"> - AT#PADFWD and AT#PADCMD commands <p>Removed parameter no more present in #EMAILD command from the example (page 61)</p> <p>Added new features related to SW release 10.0.03 such as:</p> <ul style="list-style-type: none"> - AT#BASE64 command - AT#SGACTCFGEXT command <p>Added note in Easy GSM chapter, about COPS and CSURV commands</p>
7	2009-08-24	<p>Added new features related to sw release 7.03.01 or 7.02.06 such as:</p> <ul style="list-style-type: none"> - automatic context activation, - direct control on TCP/IP settings, - Listen auto-response, UDP Listen, - command mode data sending in Hex format, - ICMP/PING handling.
6	2009-07-31	<p>Applied new layout – shifted paragraphs accordingly</p> <p>Added explanation about escape sequence guard time</p>
5	2009-07-20	<p>Added new features related to sw release 7.03.01 or 7.02.06 such as:</p> <p>FTP in command mode (par. 3.3.4.2, 3.3.5, 3.3.6)</p>
4	2008-07-16	<p>Added new features related to sw release 7.03.00 or 7.02.05 such as: command mode connections and Easy GPRS over GSM</p>
3	2007-11-29	<p>This document has been integrated with Multi-socket User Guide and is valid from the 7.02.03 SW release</p>
2	2007-09-03	<p>updated applicability table</p> <p>new disclaimer</p>
1	2007-03-14	<p>2.3.2 Easy GPRS – Email sending application: added new examples</p>
0	2007-02-01	<p>Initial release</p>

From Mod.0817 rev.1

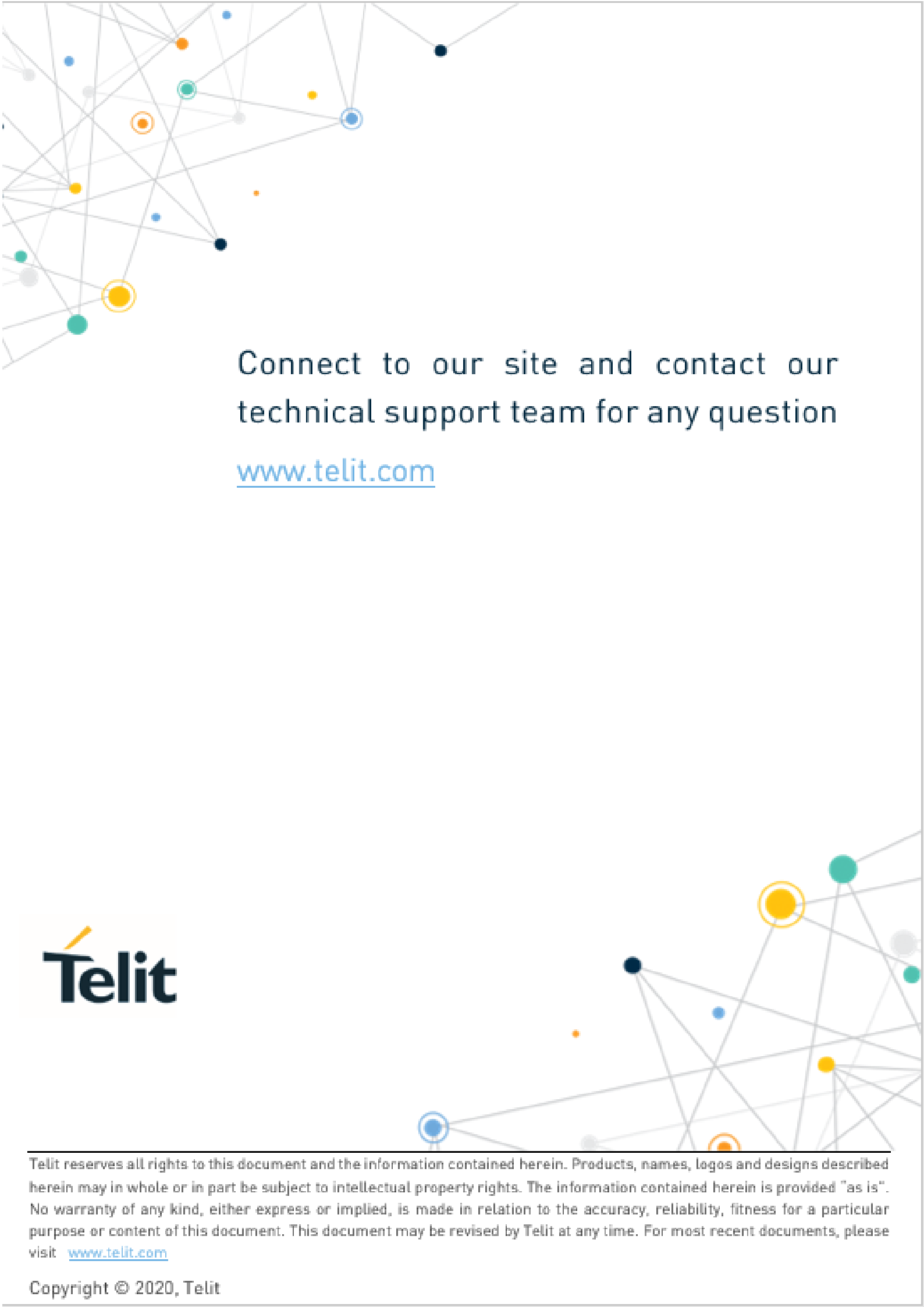

Connect to our site and contact our technical support team for any question

www.telit.com

Telit

Telit reserves all rights to this document and the information contained herein. Products, names, logos and designs described herein may in whole or in part be subject to intellectual property rights. The information contained herein is provided "as is". No warranty of any kind, either express or implied, is made in relation to the accuracy, reliability, fitness for a particular purpose or content of this document. This document may be revised by Telit at any time. For most recent documents, please visit www.telit.com

Copyright © 2020, Telit